



# Stackable Twin Beds

Model Number: DL7431      UPC Code: 0-65857-19739-6      Color: ESPRESSO

Congratulations on your latest furniture purchase! **Dorel Living** furniture has been developed with quality, convenience and style in mind. We trust it will provide you with many years of exceptional comfort and service.

Before beginning assembly, we encourage you to familiarize yourself with your new furniture piece by taking a few minutes to go through this booklet. It contains important information on our warranty and care tips to keep your furniture looking as good as new.

For more great furniture ideas, check out our website at [www.dorelliving.com](http://www.dorelliving.com) You can also keep up to date on all the latest trends by liking our [Facebook page](#) and [Instagram page](#).

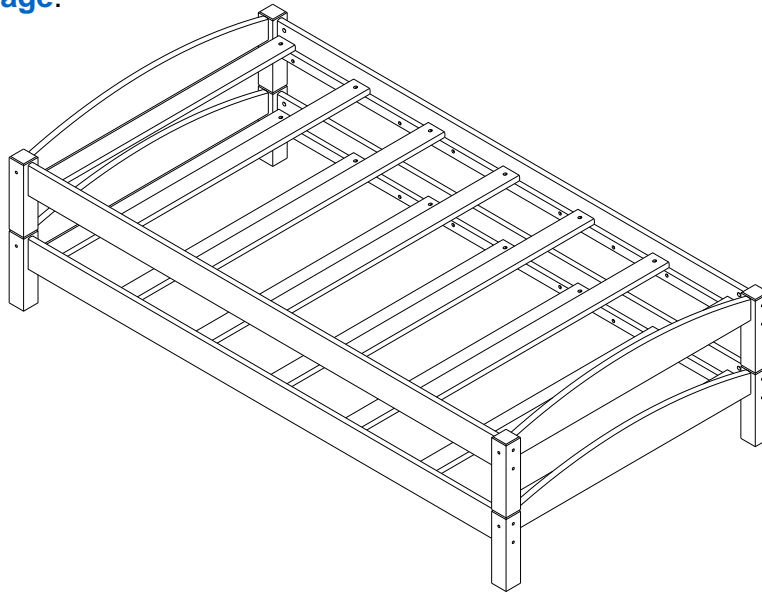

Date of Purchase: \_\_\_\_ / \_\_\_\_ / \_\_\_\_

Lot Number: \_\_\_\_\_  
(taken from carton)

Questions, concerns, missing parts? Customer satisfaction is important to us at Dorel Asia. **CONTACT OUR CUSTOMER SERVICE DEPARTMENT BEFORE RETURNING PRODUCT TO THE RETAILER.**

Our agents are available Monday to Friday 8am to 5pm (EST) to take your call and answer any questions. For faster service, always have the model number ready when contacting us.

Toll free #: 1-800-295-1980

You can also reach us by email or by visiting our website and clicking on the Support tab:  
[das@dorel.com](mailto:das@dorel.com)

**NOTE: THIS INSTRUCTION BOOKLET CONTAINS IMPORTANT SAFETY INFORMATION. PLEASE READ AND KEEP FOR FUTURE REFERENCE.**

## CUSTOMER SERVICE

You can also contact us by writing to the address listed below. Please include the product model number, color and a detailed description of your enquiry.

**Dorel Living - Customer Service Department**  
**12345 Albert-Hudon Boulevard, Suite 100**  
**Montreal, Quebec**  
**Canada, H1G 3L1**

## NOTES AND INSTALLATION

### WARNING

Ensure all parts and components are present before beginning assembly.  
Assemble on a soft, smooth surface to prevent damage to the product finish.  
Read all instructions before use.  
A Phillips head screw driver is not included.  
**DO NOT** use power tools.  
CAUTION: Adult assembly required.  
Assembly may require two people.  
Estimated assembly time: 30 minutes.

## CARE, CLEANING AND MAINTENANCE

Dust regularly with a soft, lint-free cloth to prevent soil build-up. A damp cloth may be used occasionally to clean surface. Dry immediately. Do not use any abrasives that may damage finish.  
Excessive exposure to sunlight and extreme changes in temperature and moisture can damage wood furniture.  
Check all bolts, screws and fasteners periodically and tighten them if necessary.

## 1-YEAR LIMITED WARRANTY

Dorel warrants its product to be free from defects in material and workmanship and agrees to remedy any such defect. This warranty covers 1 year from the date of original purchase from authorized retailers. This warranty is valid only upon presentation of proof of purchase. This is solely limited to the repair or replacement of defective furniture components and no assembly labor is included. This warranty does not apply to any product which has been improperly assembled, subjected to misuse or abuse or which has been altered or repaired in any way. The warranty does not cover wearing, tearing, fading or splitting







**WARNING: Should this product become damaged, and/or components are broken or missing, DO NOT USE.**

# Stackable Twin Beds

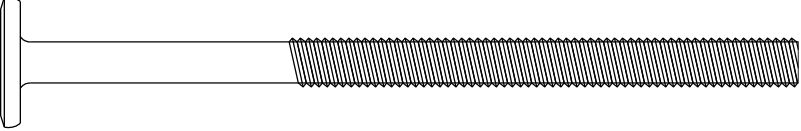
DL7431

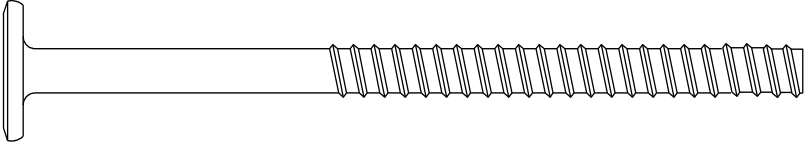
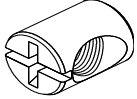
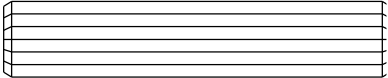
## HARDWARE LIST

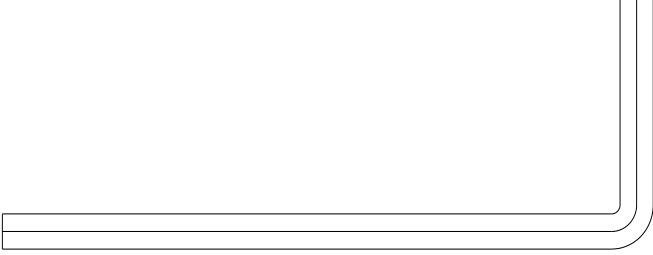
<p><b>1</b></p> 	<p><b>2</b></p> 
<p>Ø1/4" x 100mm JOINT CONNECTOR (4mm HEX HEAD) 16 PCS</p>	<p>Ø4mm x 35mm FLAT HEAD WOOD SCREW 28 PCS</p>
<p><b>3</b></p> 	<p><b>4</b></p> 
<p>Ø6.5mm x 100mm WOOD JOINT CONNECTOR (4mm HEX HEAD) 8 PCS</p>	<p>Ø11.8mm x 15mm BARREL NUT 16 PCS</p>
<p><b>5</b></p> 	<p><b>6</b></p> 
<p>Ø10mm x 50mm WOOD DOWEL 16 PCS</p>	<p>Ø10mm x 50mm METAL DOWEL 4 PCS</p>
<p><b>7</b></p> 	
<p>ALLEN KEY 1 PC</p>	

# Stackable Twin Beds

DL7431

## PARTS LIST

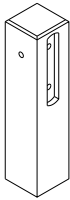
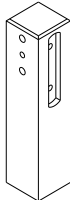
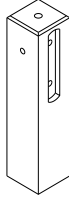
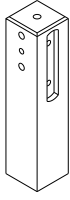
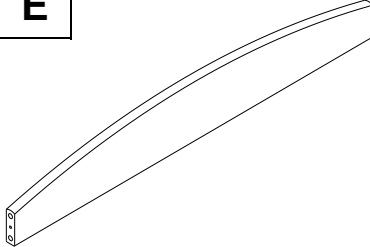
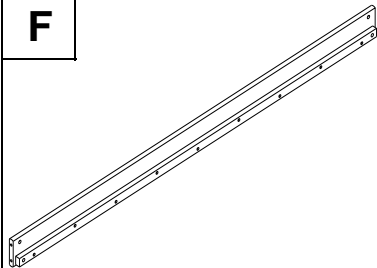
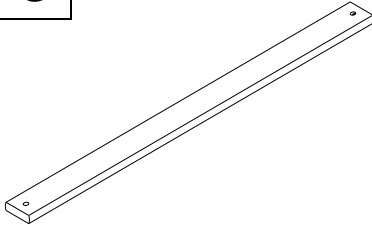
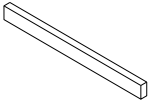
<p><b>A</b></p> 	<p><b>B</b></p> 	<p><b>C</b></p> 
<p>TOP POST 2 PCS</p>	<p>TOP POST 2 PCS</p>	<p>BOTTOM POST 2 PCS</p>
<p><b>D</b></p> 	<p><b>E</b></p> 	<p><b>F</b></p> 
<p>BOTTOM POST 2 PCS</p>	<p>HEADBOARD TOP CROSS 4 PCS</p>	<p>SIDE RAIL 4 PCS</p>
<p><b>G</b></p> 	<p><b>H</b></p> 	
<p>SLAT 14 PCS</p>	<p>SPACE BLOCK 2 PCS</p>	

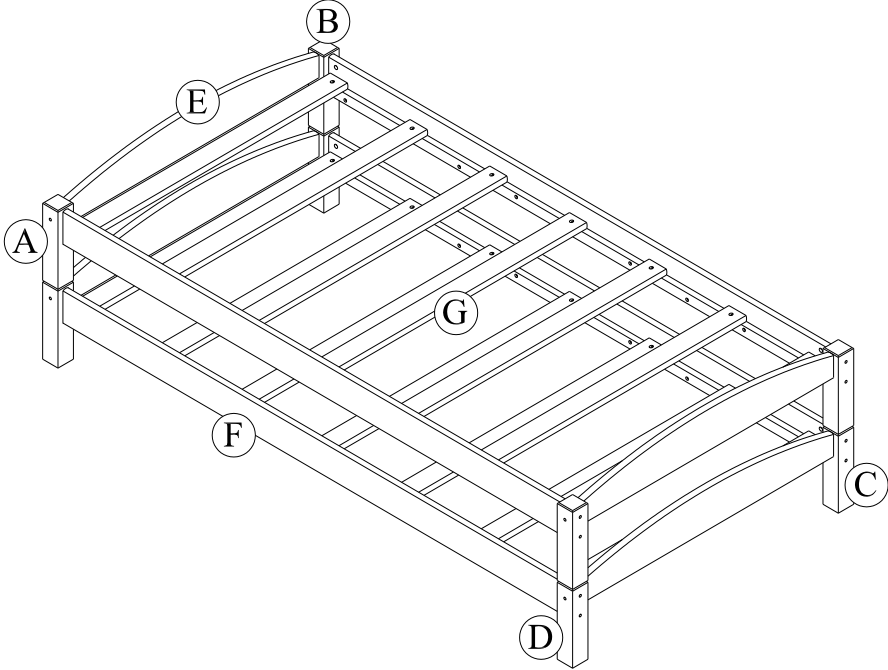

# Stackable Twin Beds

DL7431

## STEP 1

Insert wood dowels (5) into the ends of headboard top cross (E) .  
Attach top posts (A) & (B) using wood joint connectors (3) as shown.

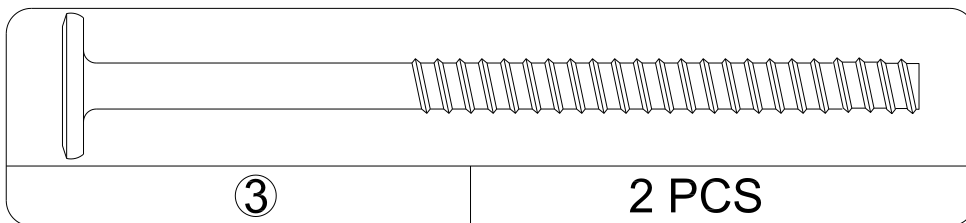
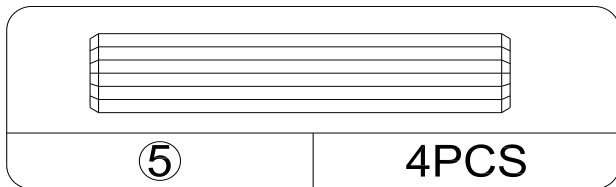
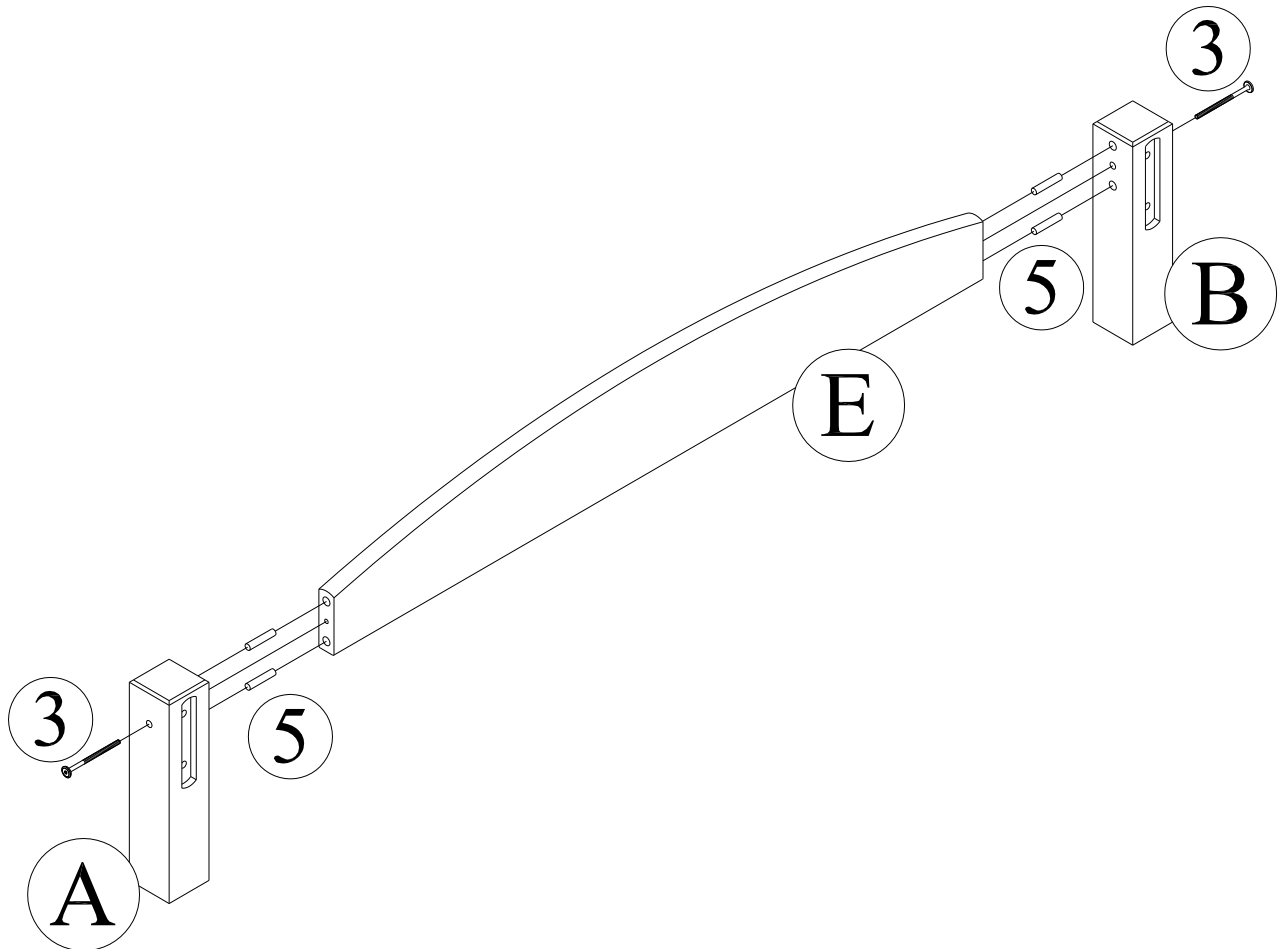

# Stackable Twin Beds

DL7431

## STEP 2

Repeat the previous step to assemble the remaining three sets of headboards.

Be sure to pair the bottom posts (C) and (D) for one pair; (D) and (C) for another; and the top posts (B) and (A) for the last pair.

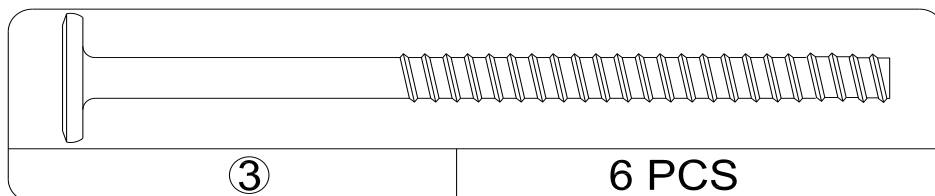
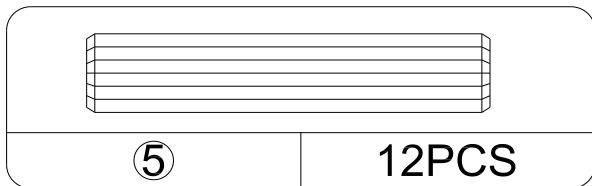
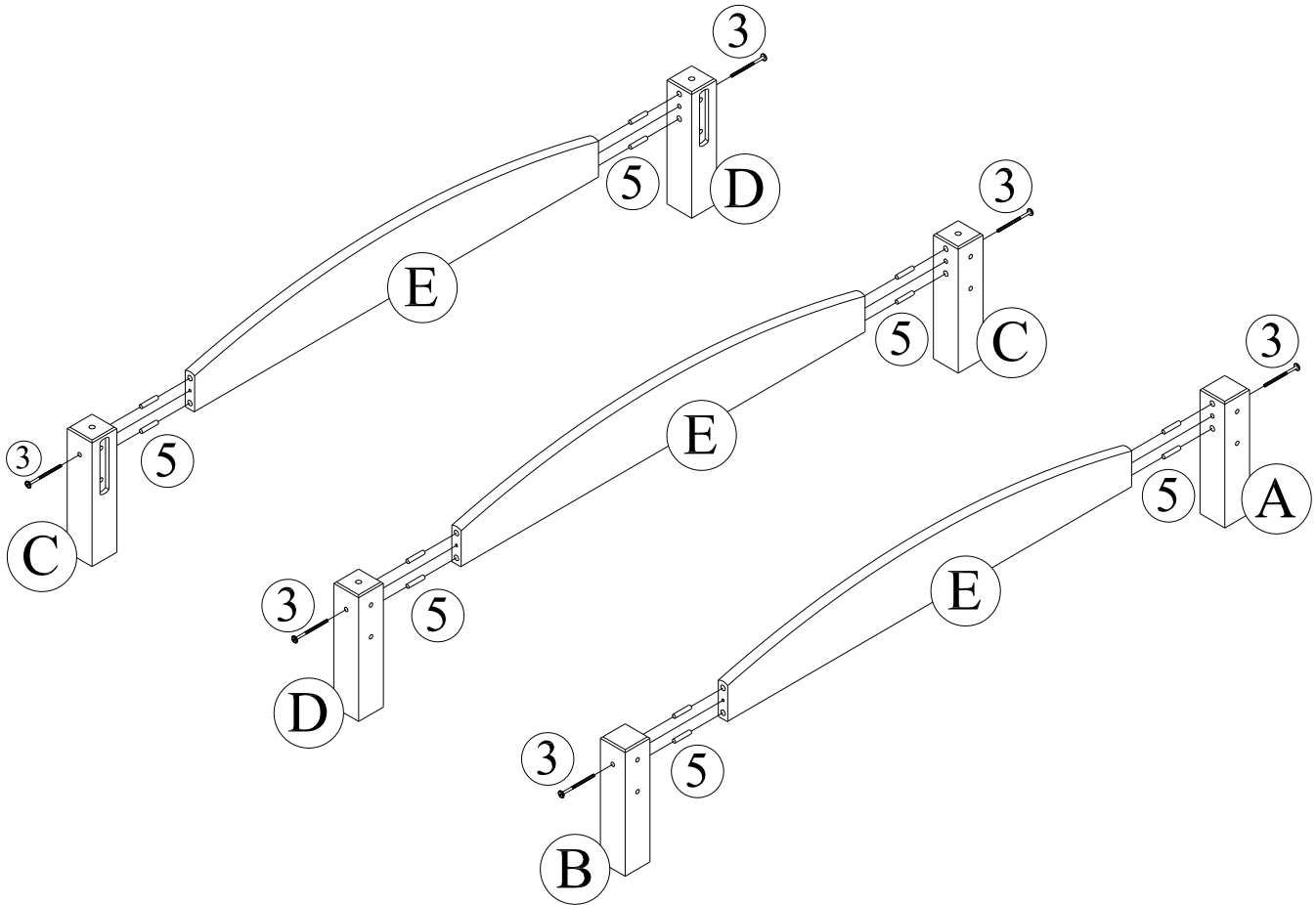

# Stackable Twin Beds DL7431

## STEP 3

Fasten side rails (F) with joint connectors (1) and barrel nuts (4).  
Use Allen key (7) to tighten all joint connectors.

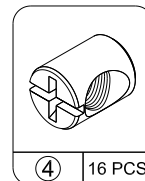
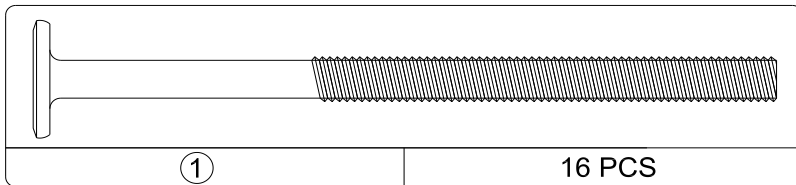
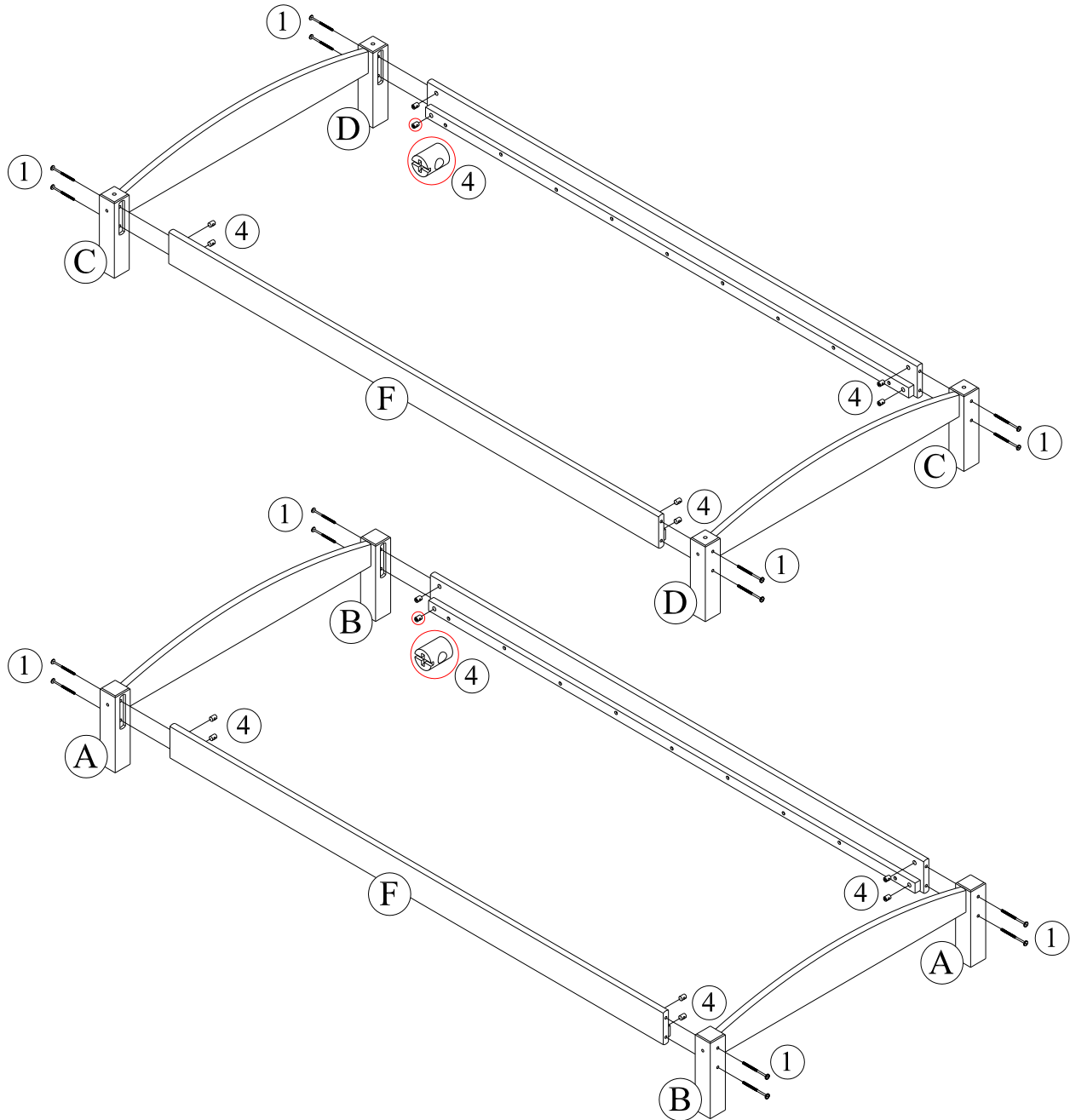

# Stackable Twin Beds

## DL7431

### STEP 4

Attach slats (G) as shown below to side rails (F) with flat head wood screws (2) using a Phillips head screw driver (not included).

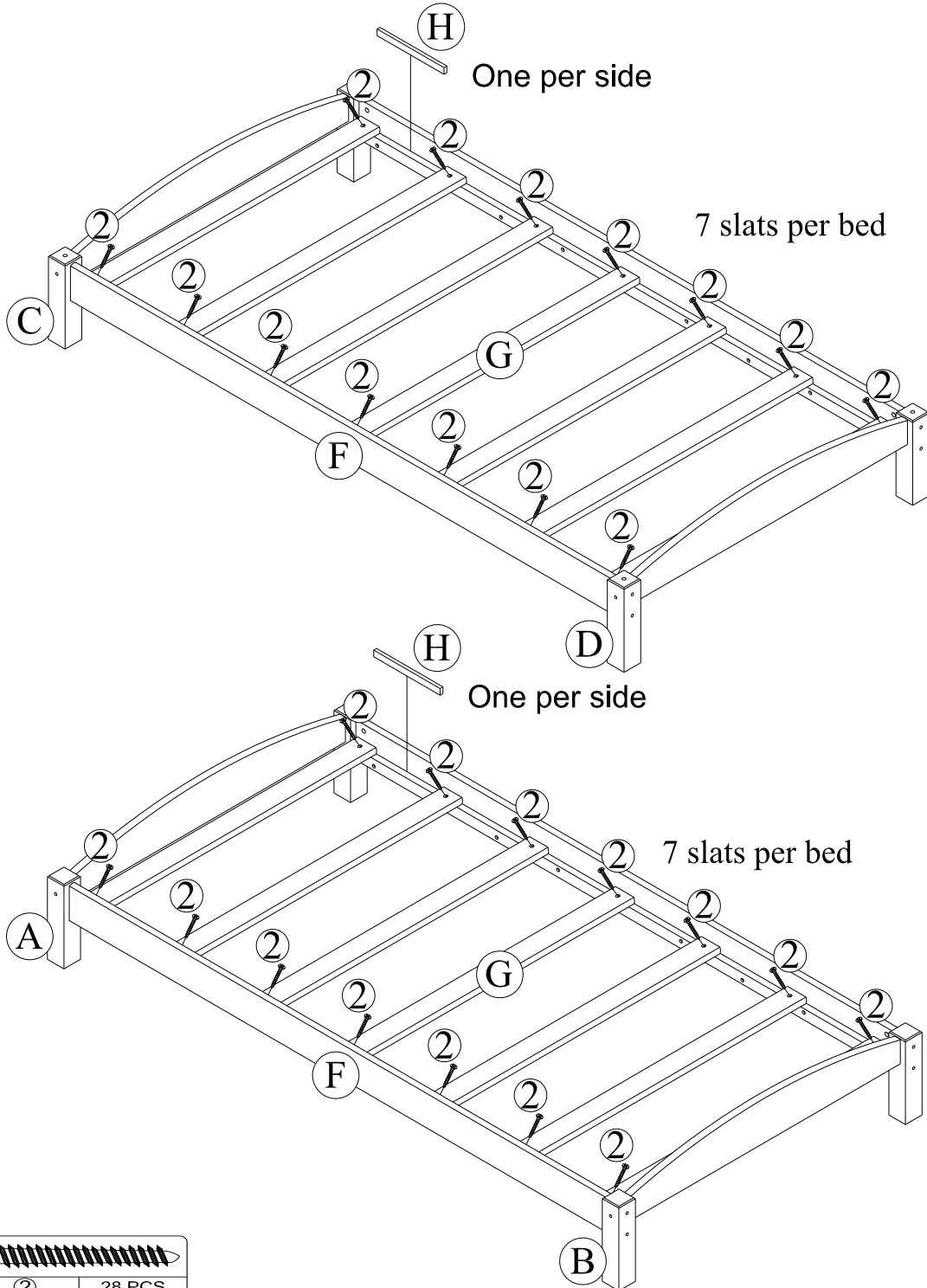



# Stackable Twin Beds

DL7431

## STACKING THE BEDS

Insert the metal dowels (6) into the corner posts (C & D). With the help of another person, stack the beds.

To separate the beds, simply unstack the beds and remove the metal dowels (6). Keep the metal dowel (6) for future use.

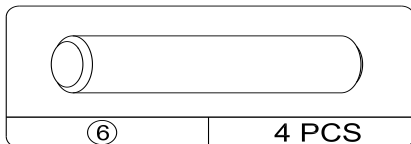
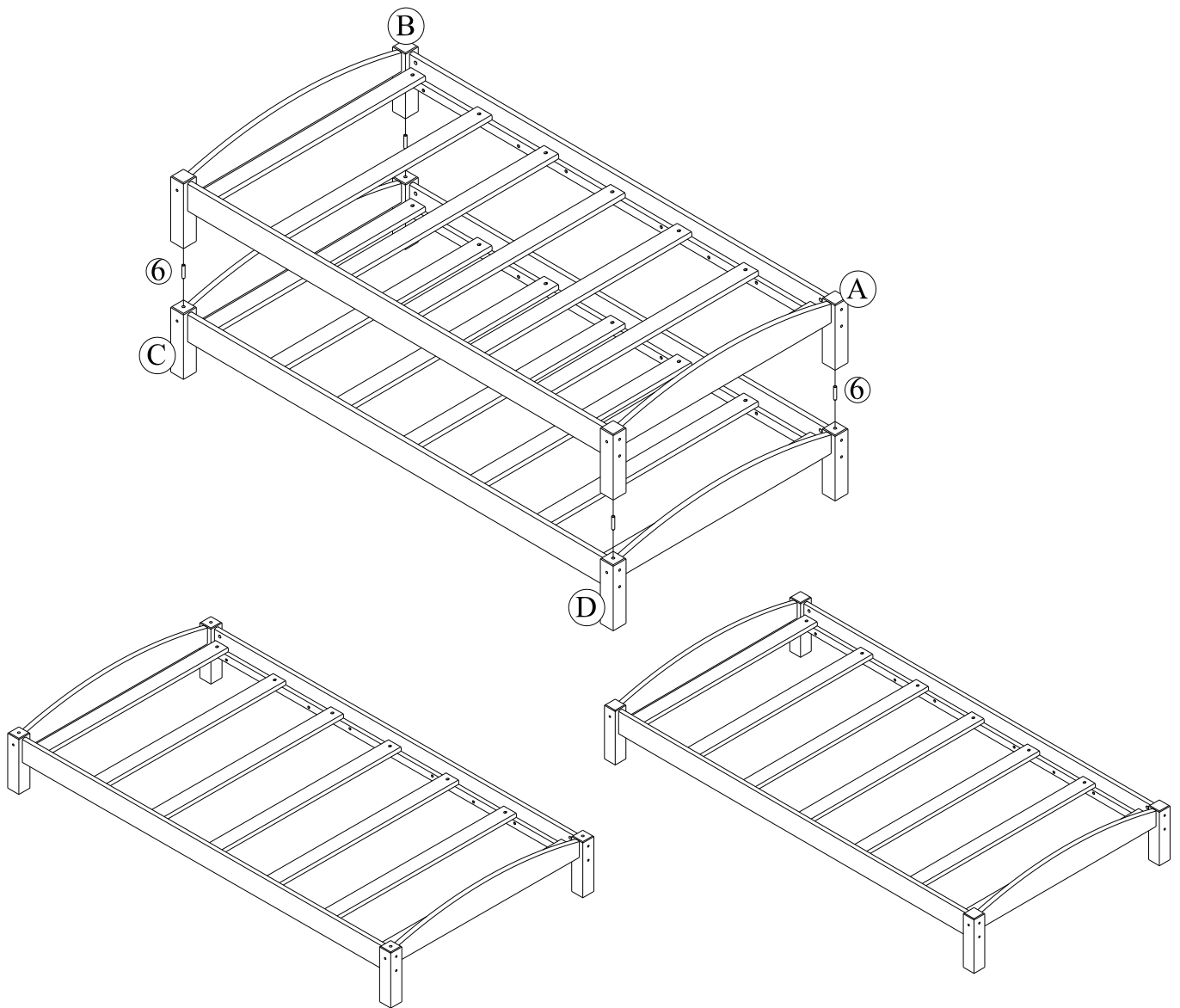

# Stackable Twin Beds

DL7431



**CAUTION:** This unit is intended for use only with the products and/or maximum weights indicated. Use with other products and/or products heavier than the maximum weights indicated may result in instability or cause possible injury.

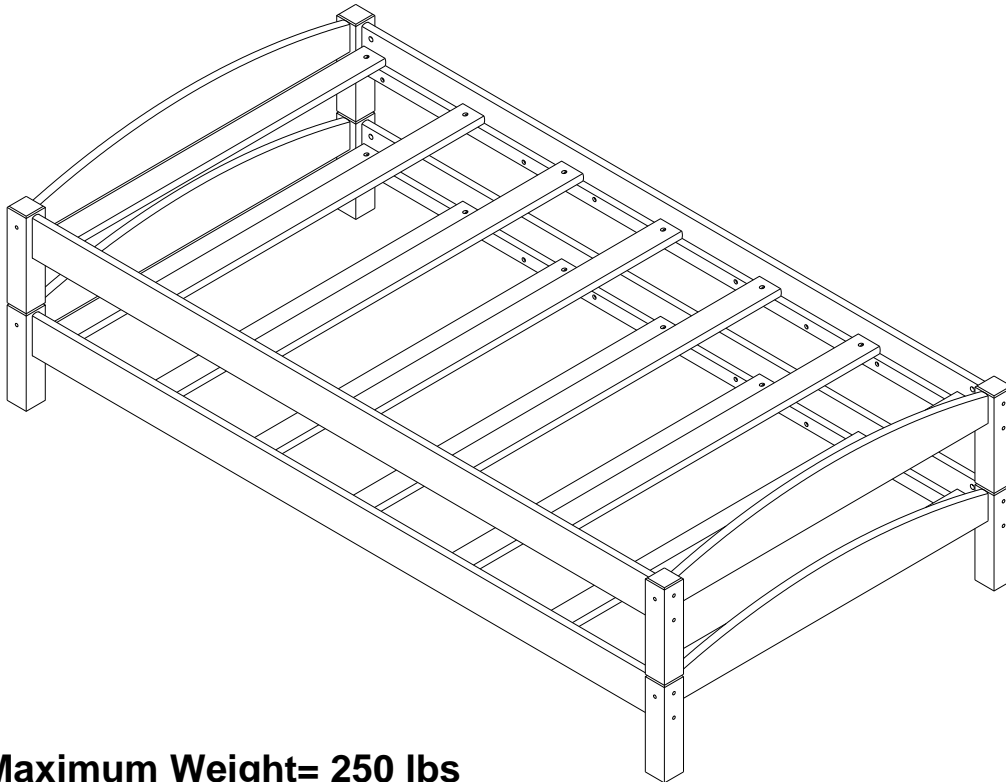

**Maximum Weight= 250 lbs**

That's it! You've finished assembling your twin beds.

## **DO NOT RETURN PRODUCT TO THE RETAILER**

If a part is missing or damaged, contact our customer service department. We will replace the part **FREE** of charge.



Tel #: 1-800-295-1980  
E-Mail: [das@dorel.com](mailto:das@dorel.com)



## Camas gemelas apilables

Modelo No:

DL7431

CODIGO UPC:

0-65857-19739-6

Color:

EXPRESSO

¡Felicitaciones por su nueva compra de un mueble! Los muebles de la línea **Dorel Living** han sido diseñados con la calidad, la comodidad y el estilo en mente. Estamos seguros de que este mueble le servirá por muchos años con su comodidad excepcional.

Le recomendamos que antes de comenzar a armarlo se familiarice con su nueva compra y tome unos minutos de su tiempo para leer este manual. Contiene información importante sobre nuestra garantía y consejos de cuidados para que su mueble siempre conserve su apariencia de nuevo.

Para obtener más ideas de muebles inspirantes, visite nuestro sitio web en [www.dorelliving.com](http://www.dorelliving.com)

También puede mantenerse informado de todas las últimas tendencias suscribiéndose a nuestra página en [Facebook e Instagram](#).

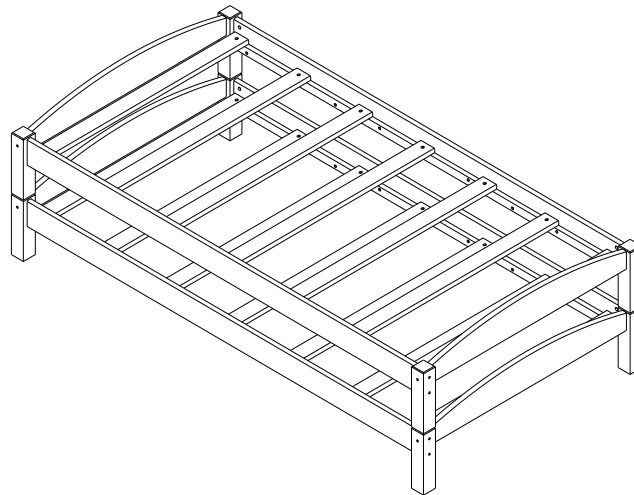

Fecha de compra: \_\_\_\_ / \_\_\_\_ / \_\_\_\_

Número de lote: \_\_\_\_\_

(tomado del cartón)

Preguntas, inquietudes, partes que faltan? La satisfacción del cliente es importante para nosotros en Dorel Asia. **CONTACTE NUESTRO DEPARTAMENTO DE SERVICIO AL CLIENTE ANTES DE DEVOLVER EL PRODUCTO A LA TIENDA.**

Nuestros agentes están disponibles de lunes a viernes de 8 a.m. a 5 p.m. (EST) para atender su llamada y responder a cualquier pregunta. Para un servicio más rápido, siempre tenga listo el número de modelo al contactarnos. Nuestro número gratuito es: 1-800-295-1980

También puede comunicarse con nosotros por correo electrónico o visitando nuestro sitio web haciendo clic en los enlaces de soporte:

[das@dorel.com](mailto:das@dorel.com)

[www.dorelliving.com](http://www.dorelliving.com)

**NOTA: ESTE MANUAL DE INSTRUCCIONES CONTIENE INFORMACIÓN DE SEGURIDAD IMPORTANTE. POR FAVOR, LÉALO Y CONSÉRVELO PARA CONSULTARLO EN EL FUTURO.**

## SERVICIO AL CLIENTE

También puede contactarnos escribiendo a la dirección que figura a continuación. Por favor incluya el número de modelo del producto, el color y una descripción detallada de su pregunta.

**Dorel Living - Customer Service Department**  
**12345 Albert-Hudon Boulevard, Suite 100**  
**Montreal, Quebec**  
**Canada, H1G 3L1**

## NOTAS E INSTALACIÓN

- \* Asegúrese de tener todas las piezas y componentes antes de comenzar a armarla.
- \* Ármela sobre superficies limpias y blandas para evitar dañar el pulido del producto.
- \* Lea todas las instrucciones antes de usar el producto.
- \* **NO** use herramientas eléctricas.
- \* **PRECAUCIÓN:** El producto debe ser armado por un adulto.
- \* Pueden necesitarse dos personas para armar el producto.
- \* Tiempo estimado para armar el producto: 30 minutos.

## CUIDADO, LIMPIEZA Y MANTENIMIENTO

Quítele el polvo regularmente con un paño suave y seco, para evitar que la suciedad se acumule. No remojar ni lavar en agua caliente. Limpie con un paño suave y húmedo si es necesario. No use abrasivos, limpiadores o productos para pulir.

Revise todos los pernos, tornillos y sujetadores periódicamente y apriételes si es necesario.

## GARANTÍA LIMITADA DE 1 AÑO

Dorel garantiza que este producto está libre de defectos de material y mano de obra y se compromete a remediar cualquier defecto de este tipo. Esta garantía cubre 1 año a partir de la fecha de compra original. Esta garantía es válida solamente con presentación de una prueba de compra. Esto se limita a la reparación o reemplazo de componentes defectuosos del mueble y no se incluye ningún trabajo de ensamblaje. Esta garantía no se aplica a ningún producto que haya sido mal ensamblado, sujeto a mal uso o abuso, o que haya sido alterado o reparado de cualquier manera. Cualquier uso, rotura o pérdida de color de la tela no están incluidos en esta garantía (donde corresponda). Esta garantía le da derechos legales específicas y usted puede también tener otros derechos que varían de estado a estado o de provincia a provincia.







**ADVERTENCIA: Si este producto está dañado y/o ciertas piezas faltan o están rotas, NO LO USE.**

# Camas gemelas apilables

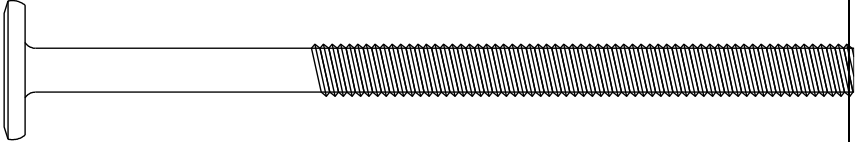
DL7431

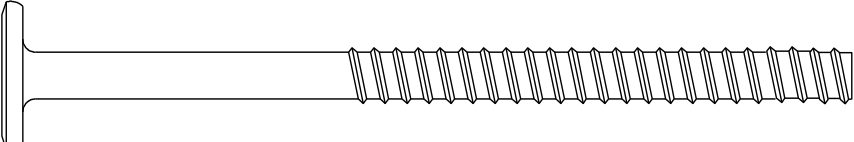
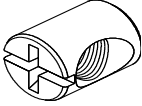
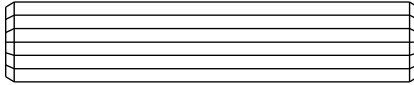
## LISTA DE ACCESORIOS

<p><b>1</b></p>  <p><math>\varnothing 1/4" \times 100\text{mm}</math></p>	<p><b>2</b></p>  <p><math>\varnothing 4\text{mm} \times 35\text{mm}</math></p>
<p>PERNO CONECTOR (4MM CABEZA HEXAG.) 16 PCS</p>	<p>TORNILLO DE CABEZA PLANA PARA MADERA 28 PCS</p>
<p><b>3</b></p>  <p><math>\varnothing 6.5\text{mm} \times 100\text{mm}</math></p>	<p><b>4</b></p>  <p><math>\varnothing 11.8\text{mm} \times 15\text{mm}</math></p>
<p>CONECTOR PARA MADERA (4MM CABEZA HEXAG.) 8 PCS</p>	<p>TUERCA BARRILETE 16 PCS</p>
<p><b>5</b></p>  <p><math>\varnothing 10\text{mm} \times 50\text{mm}</math></p>	<p><b>6</b></p>  <p><math>\varnothing 10\text{mm} \times 50\text{mm}</math></p>
<p>CLAVIJA DE MADERA 16 PCS</p>	<p>CLAVIJA DE METAL 4 PCS</p>
<p><b>7</b></p> 	
<p>LLAVE ALLEN 1 PC</p>	

# Camas gemelas apilables

DL7431

## LISTA DE PIEZAS

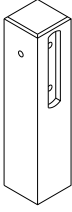
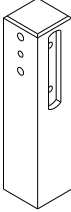
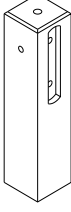
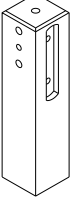
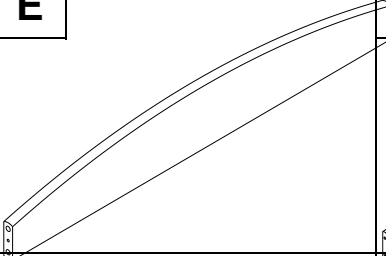
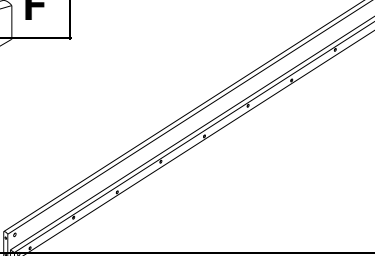
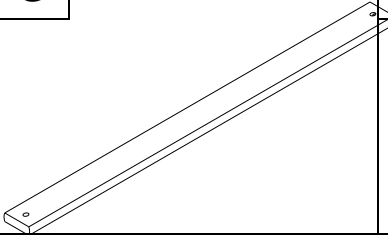
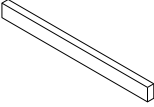
<p><b>A</b></p> 	<p><b>B</b></p> 	<p><b>C</b></p> 
<p>PATA SUPERIOR 2 PCS</p>	<p>PATA SUPERIOR 2 PCS</p>	<p>PATA INFERIOR 2 PCS</p>
<p><b>D</b></p> 	<p><b>E</b></p> 	<p><b>F</b></p> 
<p>PATA INFERIOR 2 PCS</p>	<p>TRAVESANO SUPERIOR DE CABECERA - 4 PCS</p>	<p>SOPORTE LATERAL 4 PCS</p>
<p><b>G</b></p> 	<p><b>H</b></p> 	
<p>LISTÓN 14 PCS</p>	<p>SEPARADOR 2 PCS</p>	

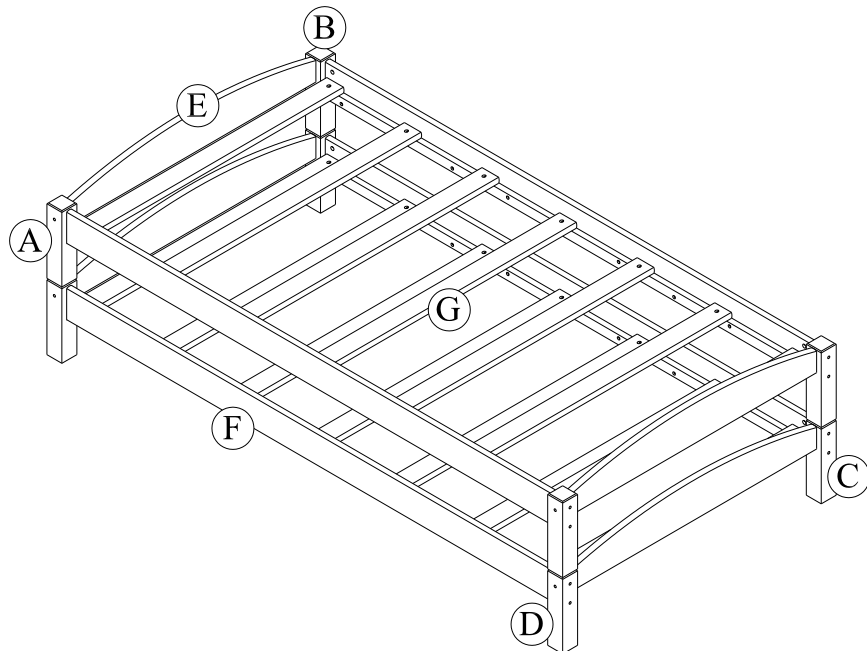

# Camas gemelas apilables

DL7431

## ETAPA 1

Inserte clavijas de madera (5) en los extremos del travesaño superior de cabecera (E).  
Fije las patas superiores (A) y (B) con conectores para madera (3) como ilustrado.

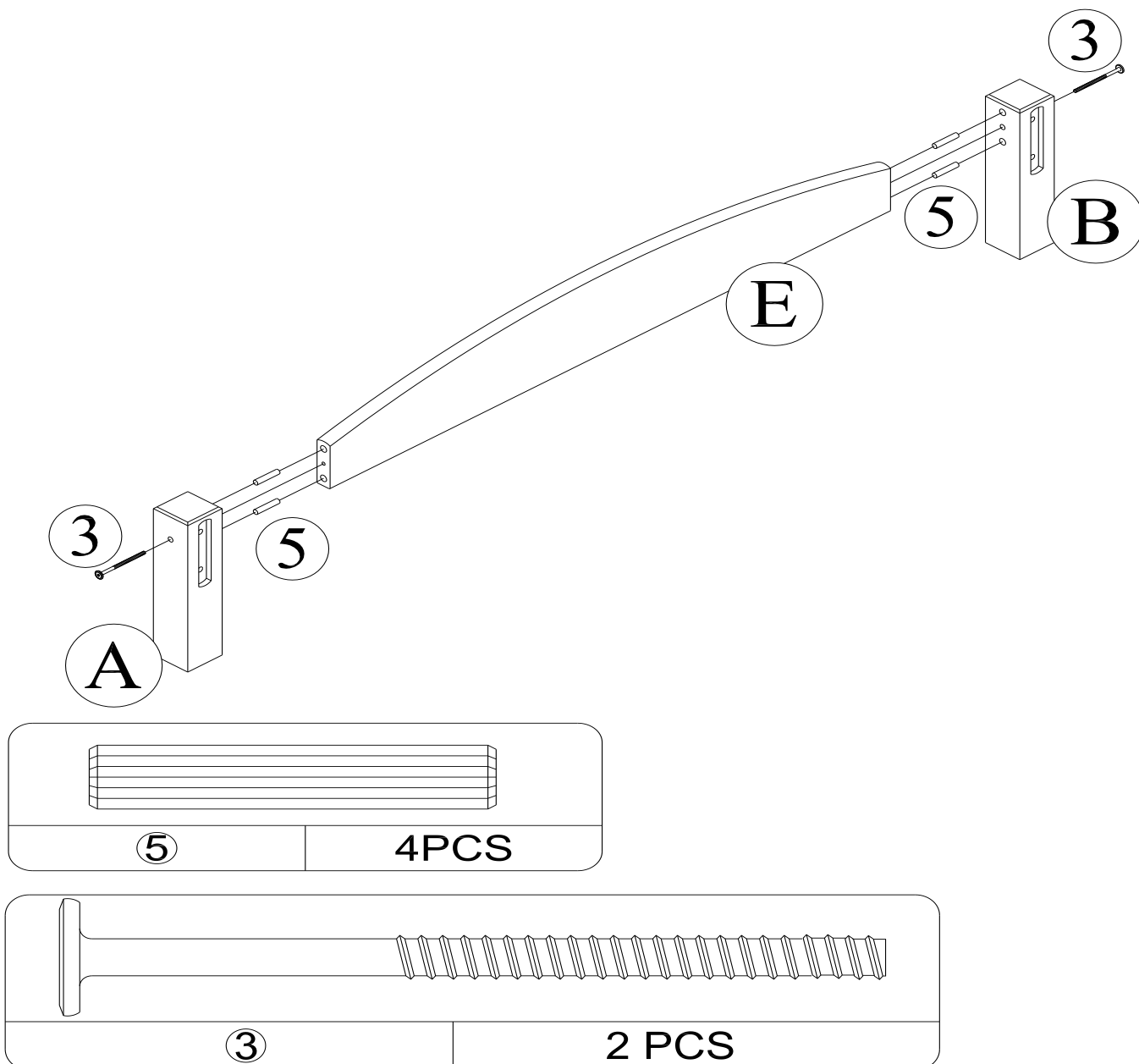

# Camas gemelas apilables

## DL7431

### ETAPA 2

Repita la etapa anterior para ensamblar los tres juegos de cabecera restantes.

Asegúrese de utilizar juntas las patas inferiores (C) y (D) para un par, (D) y (C) para otro par, y las patas superiores (B) y (A) para el último par.

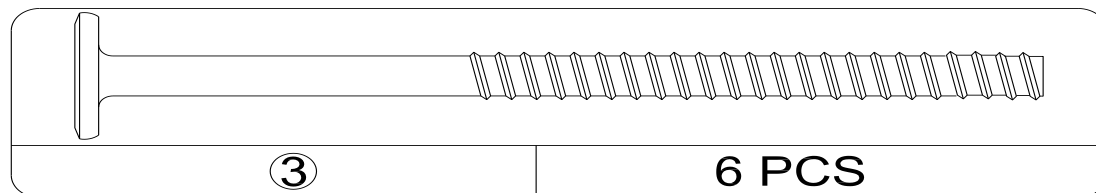
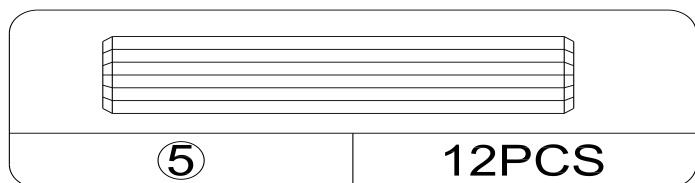
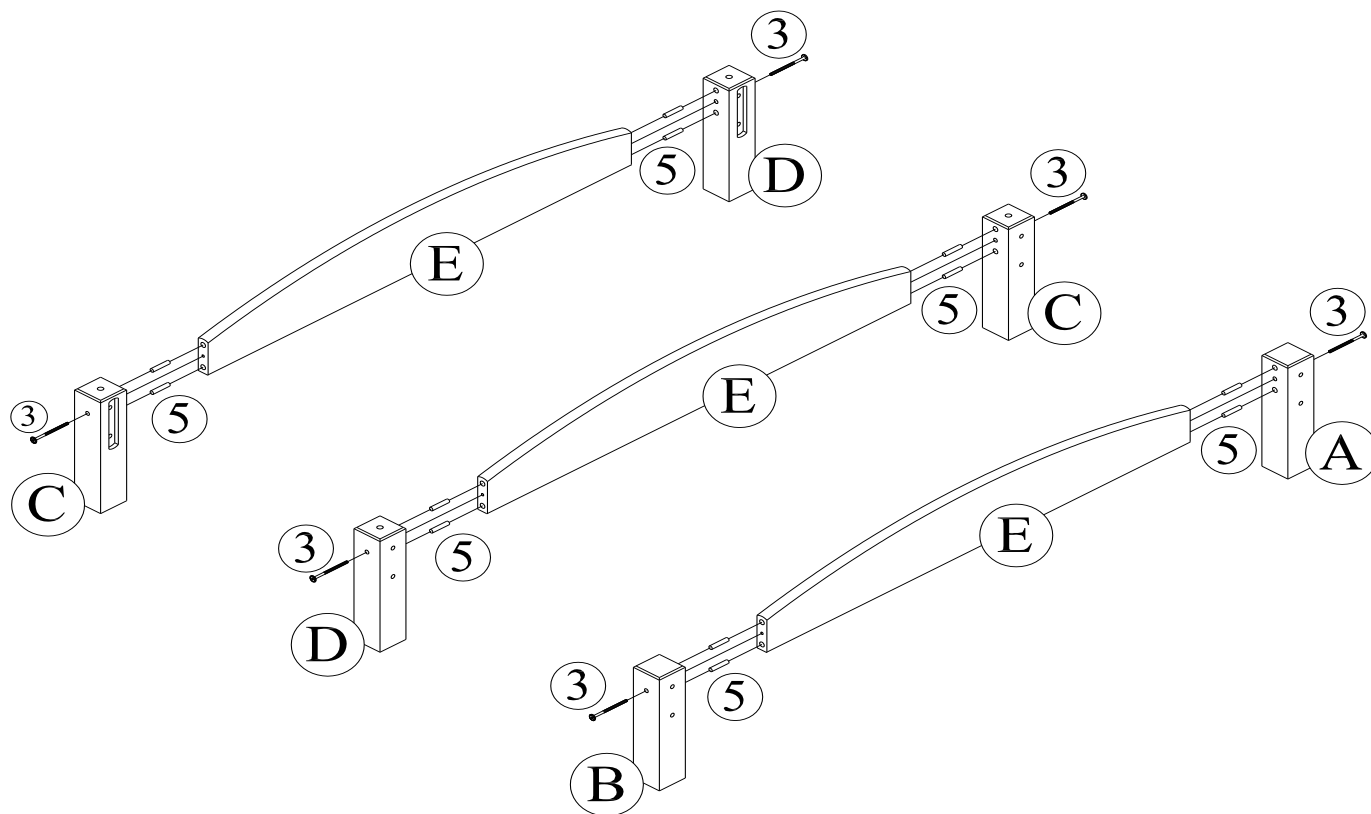



# Camas gemelas apilables

## DL7431

### Etapa 3

Fije los soportes laterales (F) con pernos conectores (1) y tuercas barrilete (4).  
Utilice la llave Allen (7) para ajustar todos los pernos conectores.

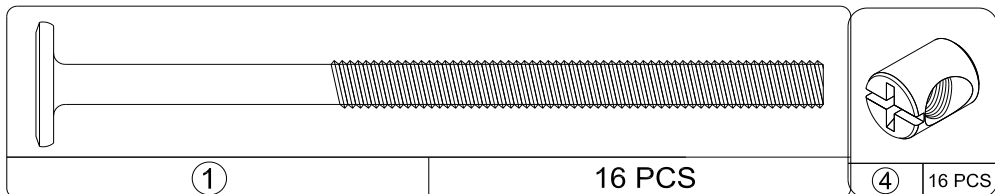
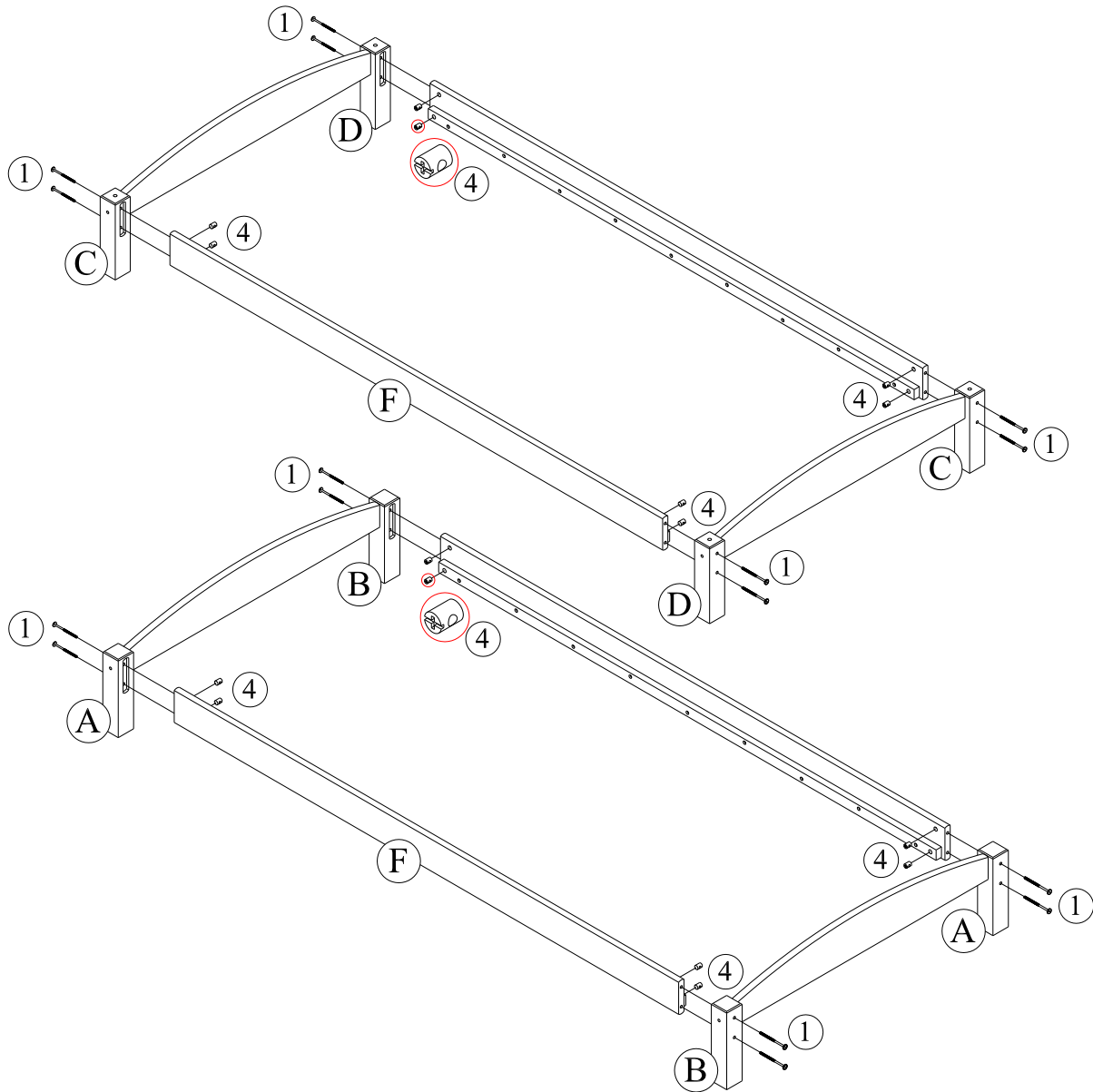

# Camas gemelas apilables

## DL7431

### Etapa 4

Coloque los listones (G) en los soportes laterales (F) como ilustrado más abajo con tornillos de cabeza plana para madera (2) y un destornillador Phillips (no incluido).

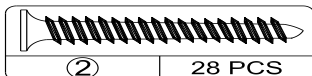
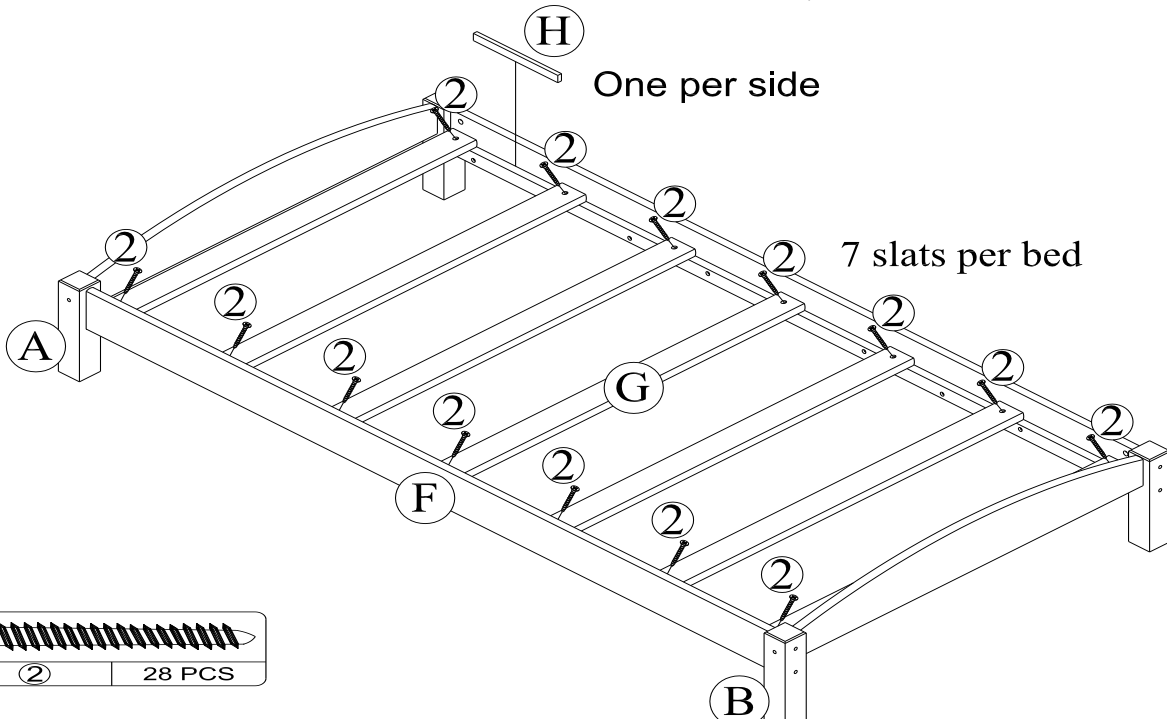
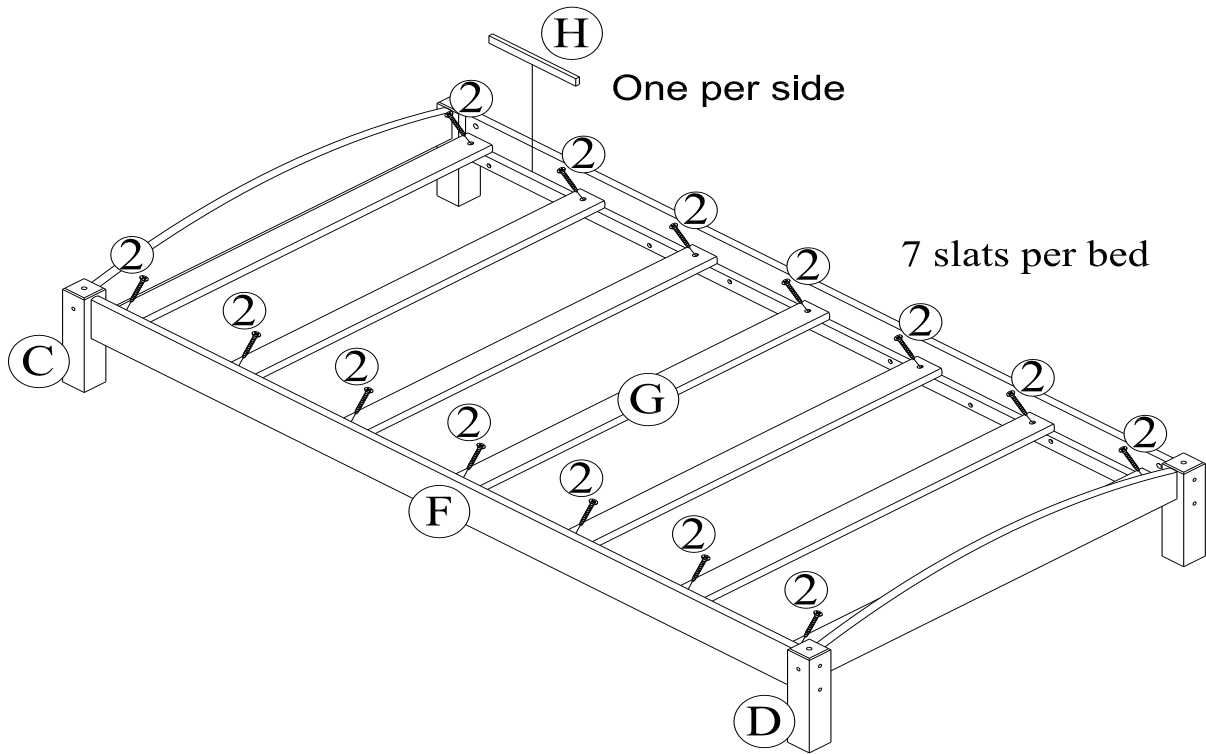

# Camas gemelas apilables

## DL7431

### PARA APILAR LAS CAMAS

Inserte las clavijas de metal (6) en las patas de los ángulos (C y D). Con la ayuda de otra persona, monte una cama sobre la otra.

Para separar las camas, simplemente desmonte la cama superior y retire las clavijas de metal (6). Conserve las clavijas de metal (6) para poder usarlas en el futuro.

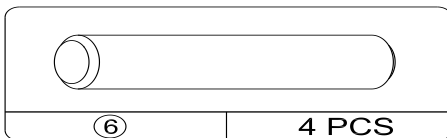
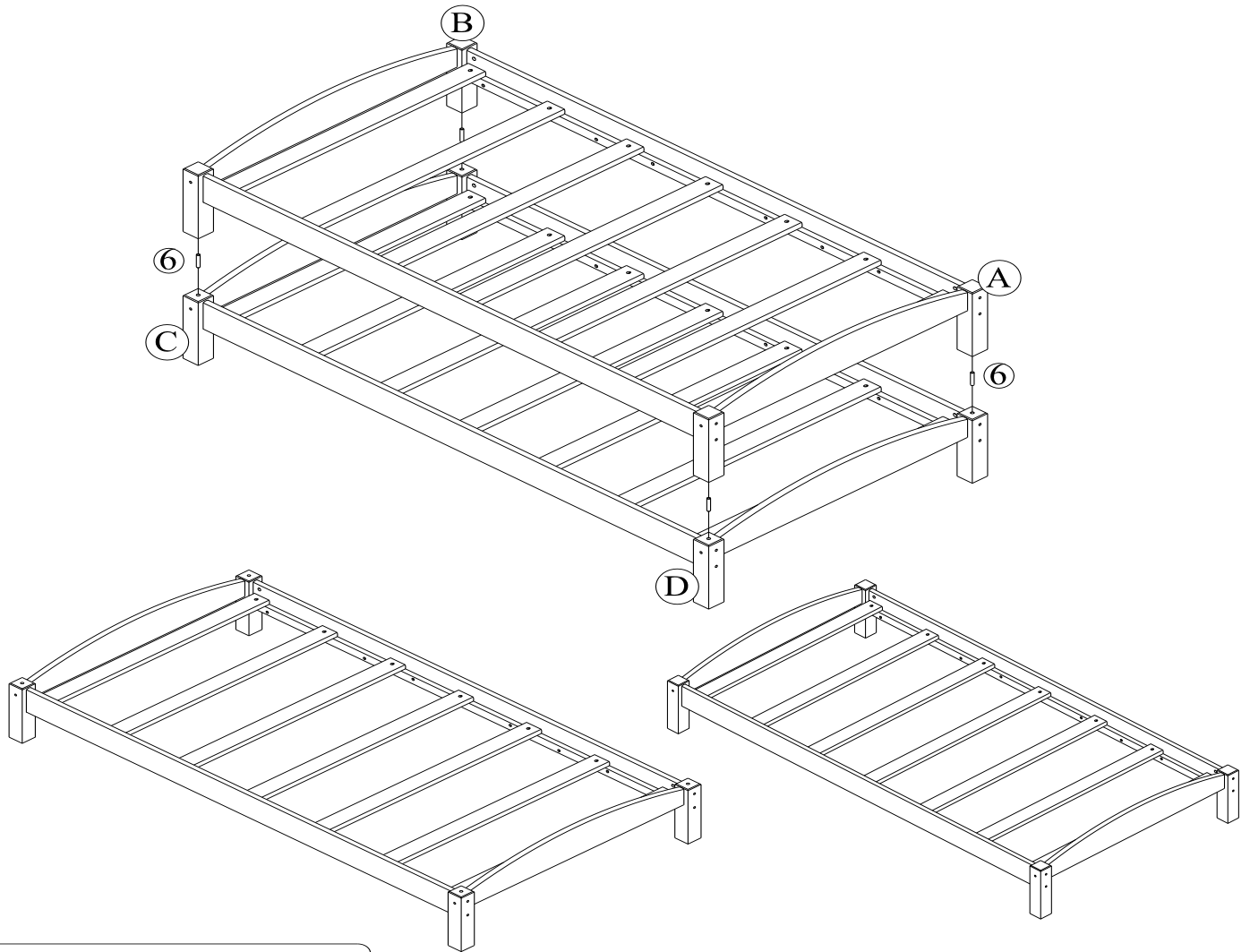

# Camas gemelas apilables

## DL7431

**!** **PRECAUCIÓN:** Esta unidad está prevista únicamente para ser usada con los productos y el peso máximo indicados. El usarla con otros productos más pesados que el peso máximo indicado puede provocar inestabilidad y causar heridas.

**Peso maximo= 250 lbs**

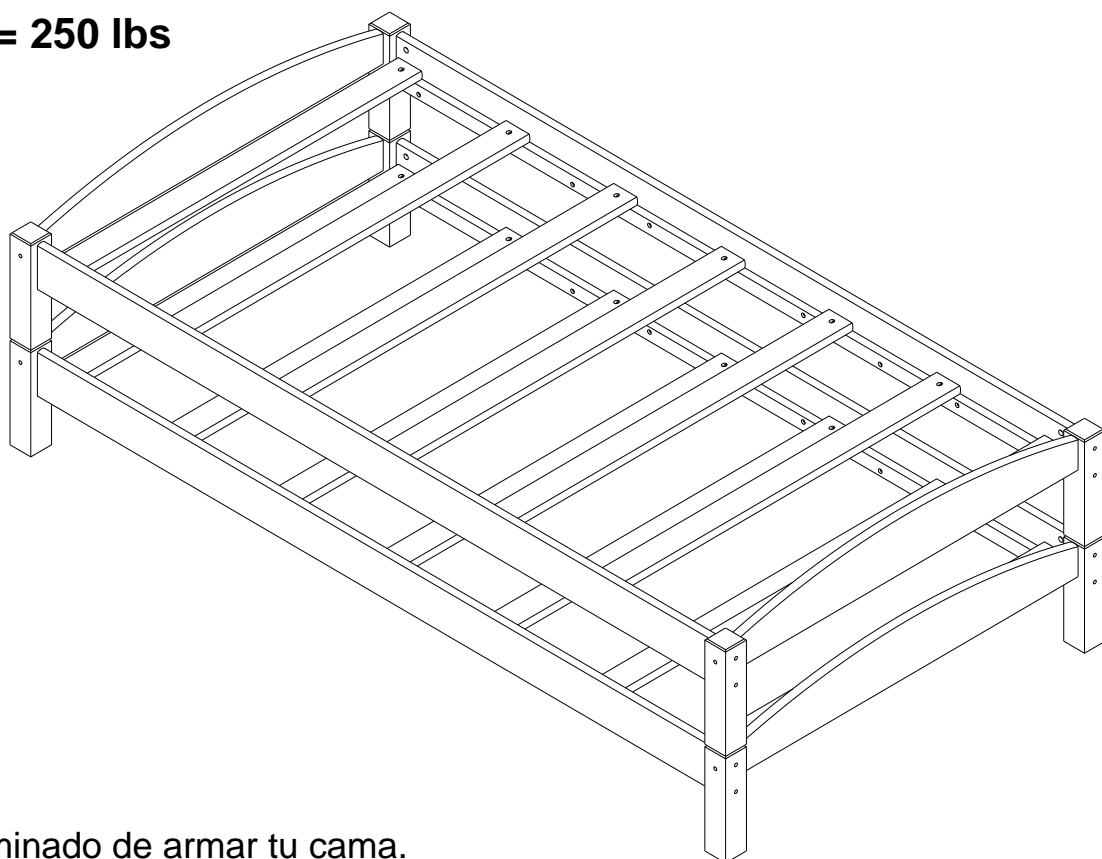

Eso es ! Has terminado de armar tu cama.

**NO DEVUELVA EL PRODUCTO A LA TIENDA.**

Si falta una pieza o está dañada, contacte nuestro departamento de servicio a la clientela.

Reemplazaremos la pieza **SIN NINGÚN** cargo.



Tel #: 1-800-295-1980

Correo electrónico: [das@dorel.com](mailto:das@dorel.com)

## Lits jumeaux superposés

Modèle No:

DL7431

Code UPC:

0-65857-19739-6

Couleur:

EXPRESSO

Félicitations pour votre dernier achat d'un meuble ! Les meubles de la ligne **Dorel Living** ont été conçus ayant en tête la qualité, la commodité et le style. Nous sommes convaincus que ce meuble vous servira durant de nombreuses années avec un confort exceptionnel.

Nous vous encourageons à vous familiariser avec les caractéristiques de votre nouveau meuble avant de commencer l'assemblage ; prenez donc quelques minutes pour lire ce manuel. Il contient de l'information importante concernant notre garantie et des conseils d'entretien pour vous assurer de garder votre meuble aussi beau qu'aux premiers jours.

Pour trouver d'autres idées inspirantes, veuillez visiter notre site web à [www.dorelliving.com](http://www.dorelliving.com)  
Vous pouvez aussi souscrire à notre page [Facebook](#) et [Instagram](#) pour être à la fine pointe de toutes les dernières tendances.

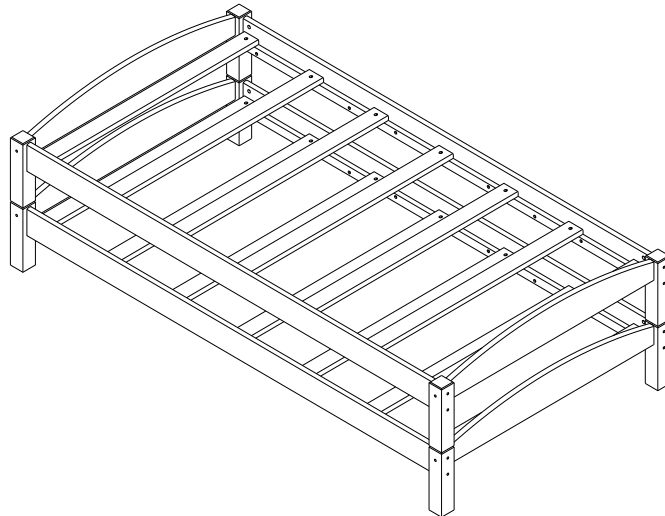

Date d'achat: \_\_\_\_ / \_\_\_\_ / \_\_\_\_

Numéro de lot: \_\_\_\_\_

(sur la boîte)

Des questions, des préoccupations, des pièces manquantes? La satisfaction du client est importante pour nous chez Dorel Asia. **CONTACTEZ NOTRE SERVICE À LA CLIENTÈLE AVANT DE RETOURNER LE PRODUIT AU DÉTAILLANT.**

Nos agents sont disponibles du lundi au vendredi de 8h à 17h (HNE) pour prendre votre appel et répondre à vos questions. Pour un service plus rapide, ayez toujours le numéro de modèle à portée de main lorsque vous nous contactez.

Sans frais #: 1-800-295-1980

Vous pouvez également nous joindre par courriel ou en visitant notre site Web et en cliquant sur les liens de support:

[das@dorel.com](mailto:das@dorel.com)

[www.dorelliving.com](http://www.dorelliving.com)

NOTE: CE MANUEL D'INSTRUCTIONS CONTIENT INFORMATION DE SÉCURITÉ **IMPORTANTE**.  
VEUILLEZ LE LIRE ET LE CONSERVER POUR RÉFÉRENCE ULTÉRIEURE.

## SERVICE À LA CLIENTÈLE

Vous pouvez également nous contacter en écrivant à l'adresse ci-dessous. S'il vous plaît inclure le numéro de modèle du produit, la couleur et une description détaillée de votre demande.

**Dorel Living - Customer Service Département**  
**12345 Albert-Hudon Boulevard, Suite 100**  
**Montreal, Québec**  
**Canada, H1G 3L1**

## NOTES ET INSTALLATION

- \* Assurez-vous que toutes les pièces et les composants sont présents avant de commencer l'assemblage
- \* Assemblez sur une surface propre et lisse pour éviter d'endommager la finition.
- \* Lisez toutes les instructions avant utilisation.
- \* **NE PAS** utiliser d'outils électriques.
- \* **ATTENTION:** Assemblage par un adulte requis.
- \* L'assemblage et la manutention nécessite deux personnes.
- \* Le temps d'assemblage estimé: 30 minutes.

## SOIN, NETTOYAGE ET ENTRETIEN

Épousseter cet article régulièrement avec un chiffon doux et non pelucheux pour empêcher la poussière de s'accumuler. Ne pas tremper ou laver à l'eau chaude. Essuyer avec un chiffon doux et humide si nécessaire. N'utilisez pas d'abrasifs, de nettoyeurs ou de vernis.

Vérifiez régulièrement tous les boulons, vis et fixations et serrez-les si nécessaire.

## GARANTIE LIMITÉE DE 1 AN

Dorel garantit que son produit est exempt de défauts de matériaux et de fabrication et accepte de remédier à un tel défaut. Cette garantie couvre un (1) an à partir de la date d'achat originale. Cette garantie est valable uniquement sur présentation d'une preuve d'achat. Cette garantie se limite exclusivement à la réparation ou au remplacement de pièces défectueuses du mobilier et aucun travail d'assemblage n'est inclus. Cette garantie ne s'applique pas à un produit qui a été assemblé incorrectement, soumis à une mauvaise utilisation ou abus, ou qui a été modifié ou réparé de quelque façon. L'usure, les déchirures ou la décoloration du tissu ne sont pas couverts par cette garantie (le cas échéant). Cette garantie vous donne des droits légaux spécifiques et vous pouvez également avoir d'autres droits qui varient d'un État à l'autre ou d'une province à l'autre.







**AVERTISSEMENT: Si ce produit est endommagé, et/ou des pièces sont brisées ou manquantes, NE PAS UTILISER.**

# Lits jumeaux superposés

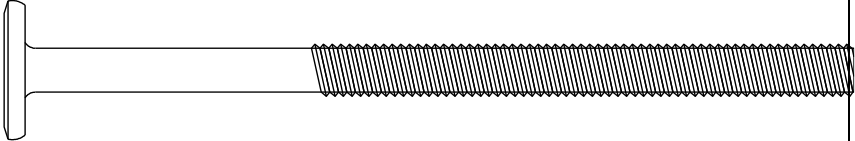
DL7431

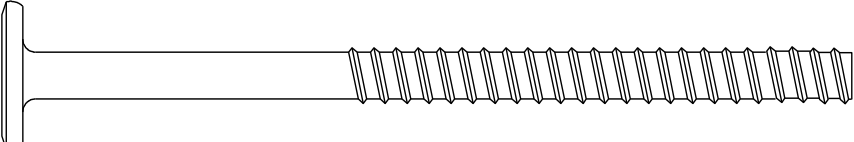
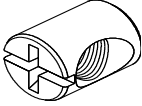
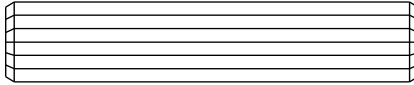
## Liste de quincaillerie

<p><b>1</b></p>  <p>Ø1/4" x 100mm</p>	<p><b>2</b></p>  <p>Ø4mm x 35mm</p>
<p>BOULON DE RACCORDEMENT (4mm TÊTE HEX.) 16 PCS</p>	<p>VIS A TÊTE PLATE POUR BOIS 28 PCS</p>
<p><b>3</b></p>  <p>Ø6.5mm x 100mm</p>	<p><b>4</b></p>  <p>Ø11.8mm x 15mm</p>
<p>RACCORDEMENT POUR BOIS (4mm TÊTE HEX.) 8 PCS</p>	<p>ÉCROU TRANSVERSAL 16 PCS</p>
<p><b>5</b></p>  <p>Ø10mm x 50mm</p>	<p><b>6</b></p>  <p>Ø10mm x 50mm</p>
<p>GOUJON DE BOIS 16 PCS</p>	<p>GOUJON DE METAL 4 PCS</p>
<p><b>7</b></p> 	
<p>CLÉ ALLEN 1 PC</p>	

# Lits jumeaux superposés

DL7431

## LISTE DE PIÈCES

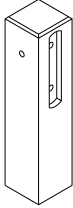
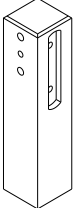
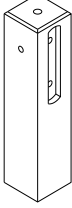
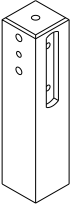
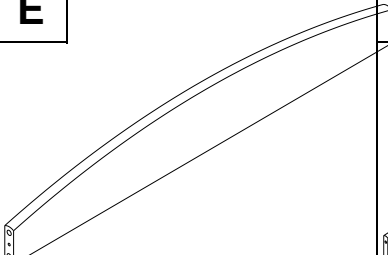
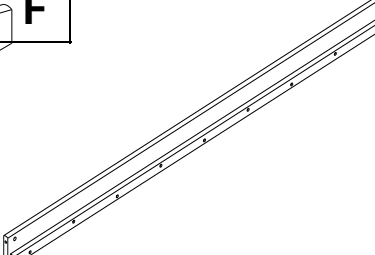
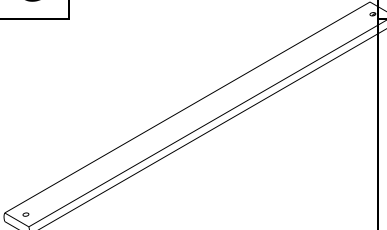
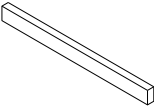
<p><b>A</b></p> 	<p><b>B</b></p> 	<p><b>C</b></p> 
<p>PIED SUPÉRIEUR 2 PCS</p>	<p>PIED SUPÉRIEUR 2 PCS</p>	<p>PIED INFÉRIEUR 2 PCS</p>
<p><b>D</b></p> 	<p><b>E</b></p> 	<p><b>F</b></p> 
<p>PIED INFÉRIEUR 2 PCS</p>	<p>TRaverse SUPÉRIEURE TÊTE DE LIT -4 PCS</p>	<p>SUPPORT LATÉRAL 4 PCS</p>
<p><b>G</b></p> 	<p><b>H</b></p> 	
<p>LATTE 14 PCS</p>	<p>BLOC D'ESPACEMENT 2 PCS</p>	

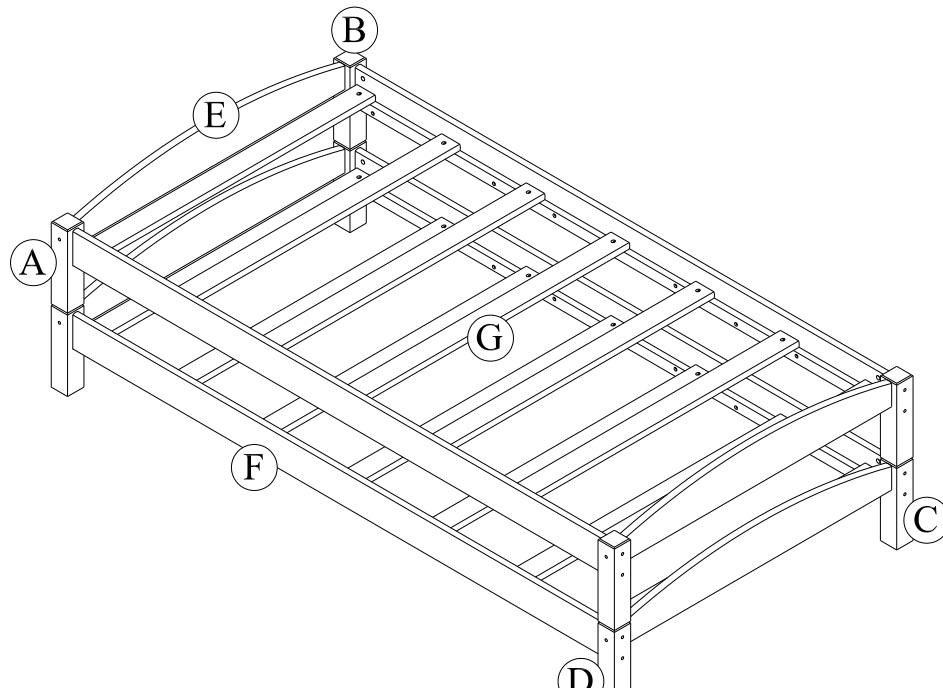



# Lits jumeaux superposés

DL7431

## ÉTAPE 1

Insérez des goujons de bois (5) dans les extrémités de la traverse supérieure de la tête de lit (E). Fixez les pieds supérieurs (A) et (B) à l'aide de raccordements pour bois (3) tel qu'illustré.

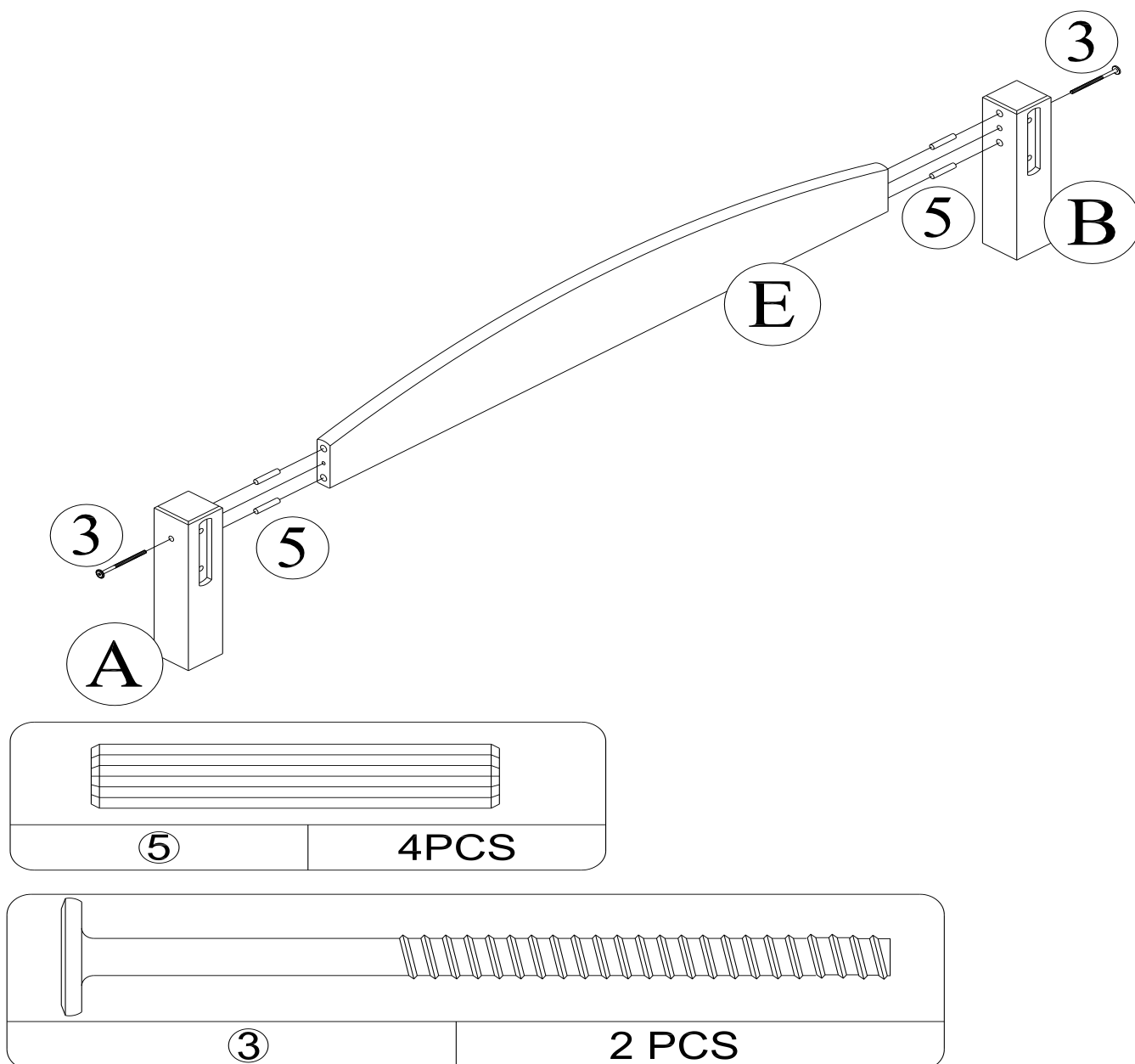

# Lits jumeaux superposés

DL7431

## ÉTAPE 2

Répétez l'étape précédente pour assembler les trois ensembles de tête de lit restants.

Assurez-vous de mettre ensemble les pieds inférieurs (C) et (D) pour une paire, (D) et (C) pour une autre, et les pieds supérieurs (B) et (A) pour la dernière paire.

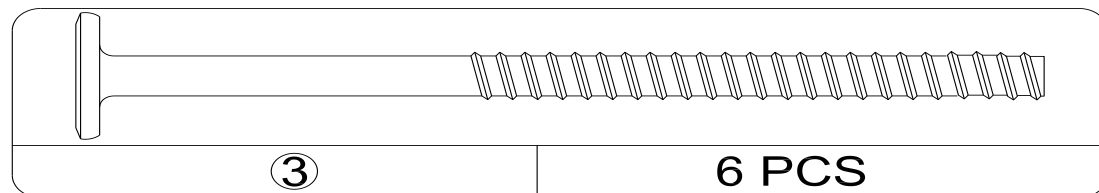
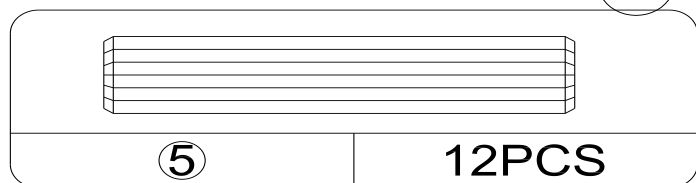
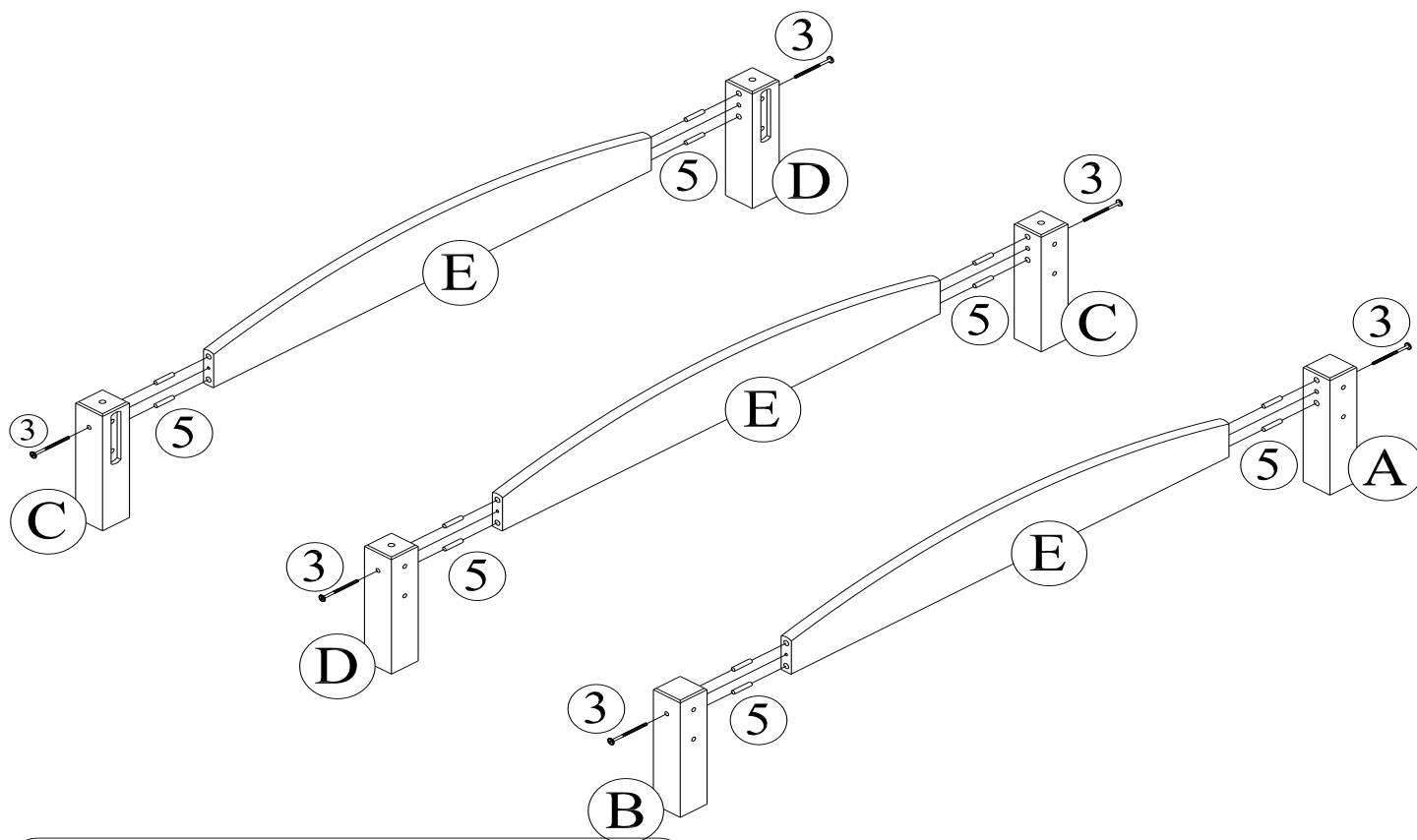

# Lits jumeaux superposés DL7431

## ÉTAPE 3

Fixez les supports latéraux (F) avec des boulons de raccordement (1) et des écrous transversaux (4). Servez-vous de la clé Allen (7) pour serrer tous les boulons de raccordement.

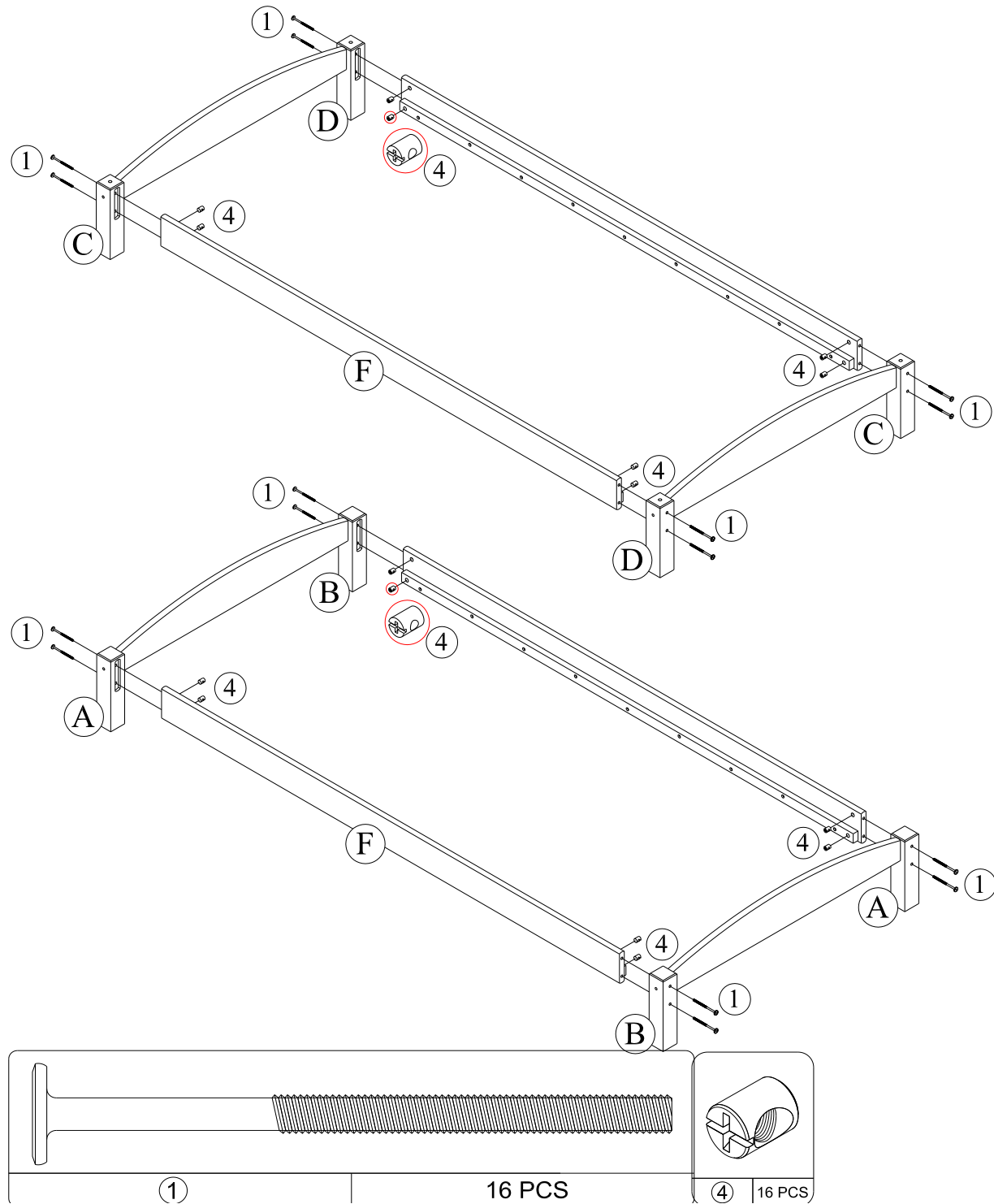

# Lits jumeaux superposés

## DL7431

### ÉTAPE 4

Attachez les lattes (G) aux supports latéraux (F) tel qu'illustré ci-dessous avec des vis à tête plate pour bois (2) à l'aide d'un tournevis cruciforme (non compris).

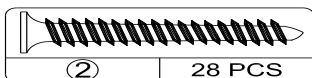
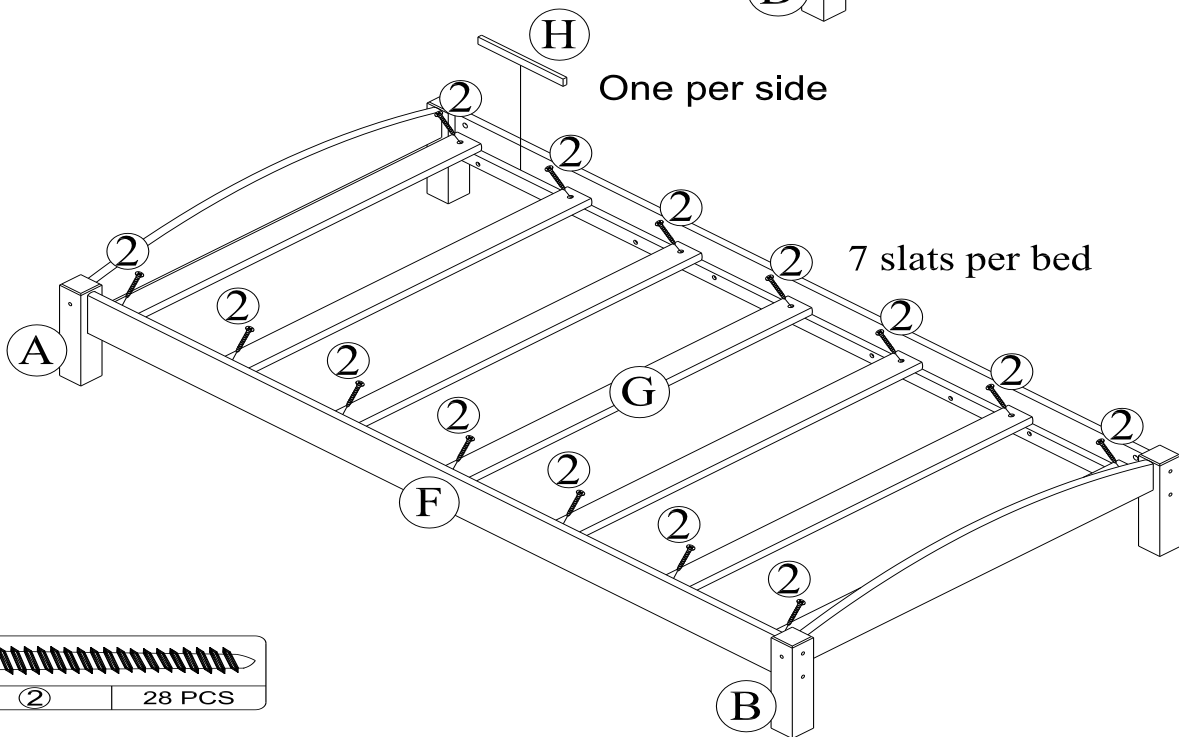
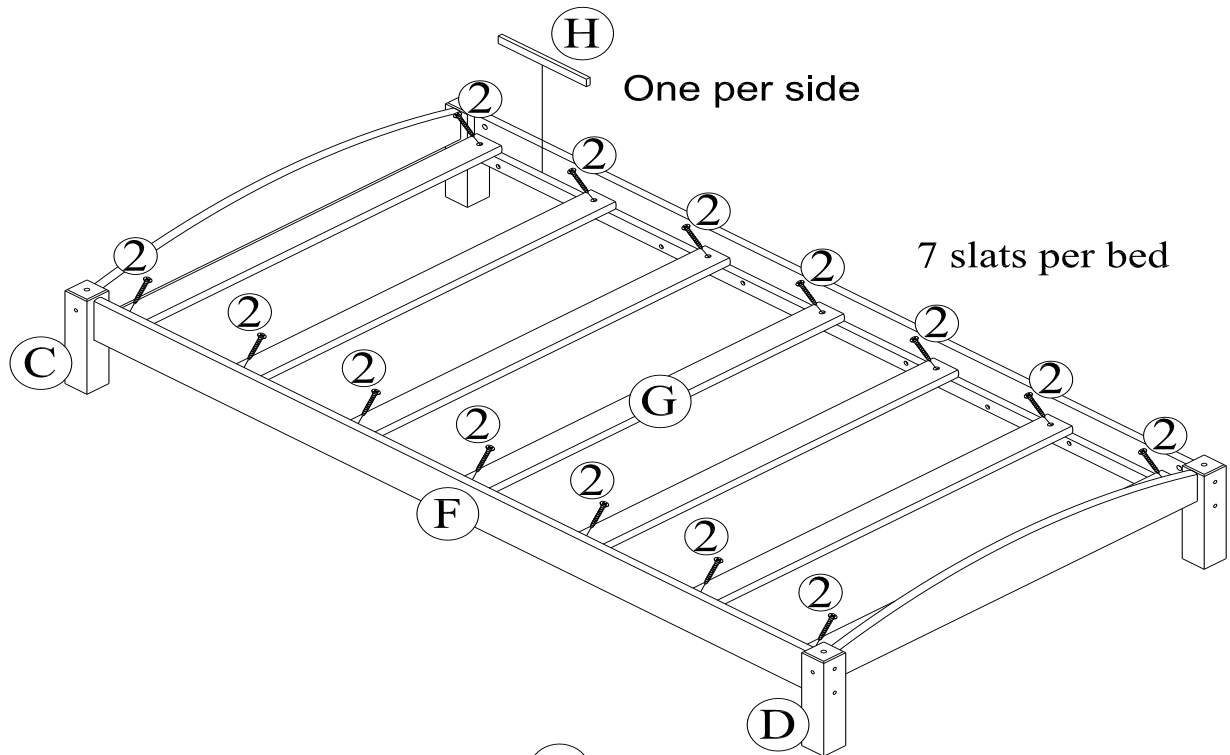

# Lits jumeaux superposés DL7431

## POUR SUPERPOSER LES LITS

Insérez les goujons de métal (6) dans les pieds des angles (C et D). Avec l'aide d'une autre personne, superposez les lits.

Pour séparer les lits, descendez le lit superposé et retirez les goujons de métal (6). Conservez les goujons de métal (6) pour pouvoir vous en servir à l'avenir.

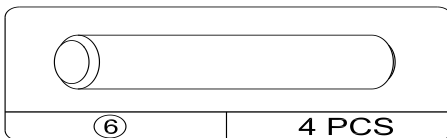
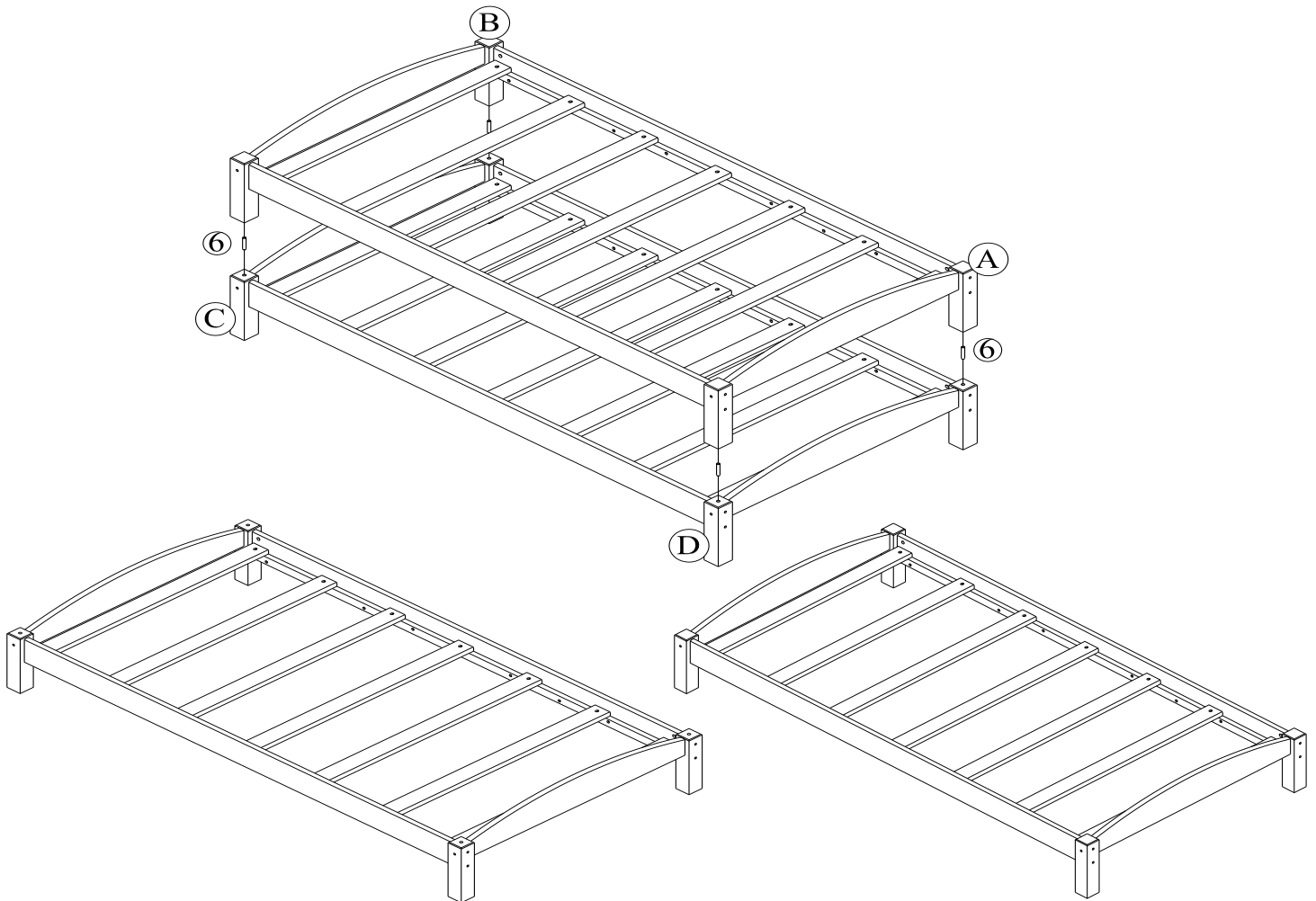

# Lits jumeaux superposés DL7431



**ATTENTION:** Cette unité est conçue pour être utilisée uniquement avec les produits et/ou les poids maximum indiqués. L'utilisation avec d'autres produits et/ou des produits plus lourds que les poids maximum indiqués peut causer de l'instabilité ou des blessures.

**Poids maximum =  
250 lbs par position.**

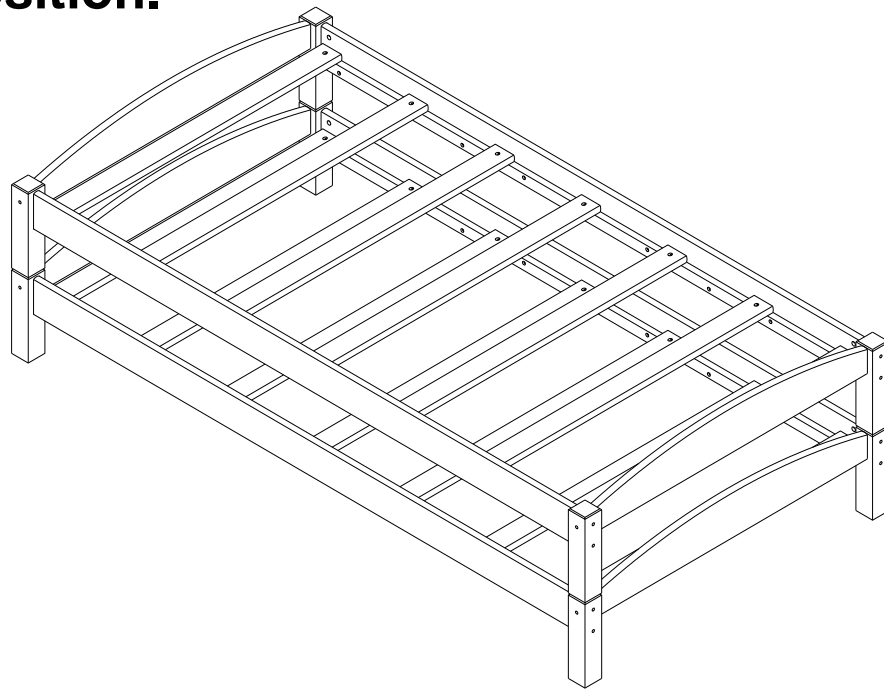

Vous avez fini d'assembler votre lit!

**NE PAS RETOURNER CE PRODUIT AU DETAILLANT.**

Si une pièce est manquante ou endommagée, contactez un représentant de notre Service à la clientèle. Nous remplacerons la pièce **GRATUITEMENT**.

Tél #: 1-800-295-1980  
Courriel: [das@dorel.com](mailto:das@dorel.com)

