

7031872COM Arcade Stand-Black/Gunmetal

Date of Purchase ___ / ___ / ___
Lot Number:

B347031872COM00KX

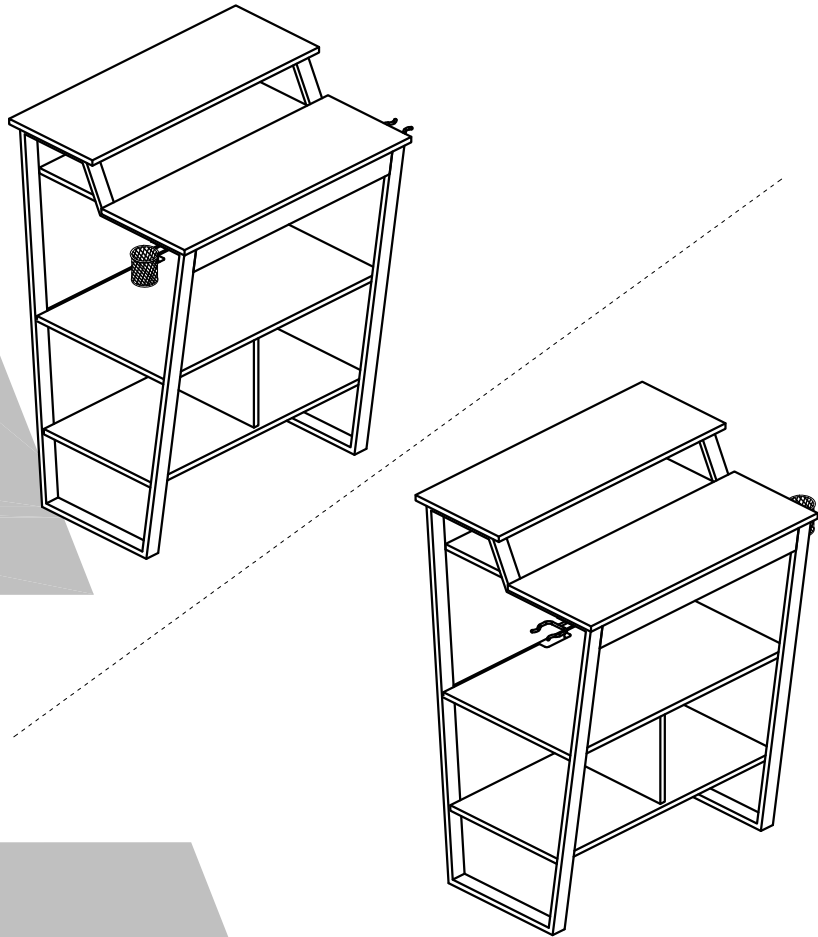

THIS INSTRUCTION BOOKLET CONTAINS **IMPORTANT** SAFETY INFORMATION. PLEASE READ AND KEEP FOR FUTURE REFERENCE.

Do Not Return This Product!

Contact our customer service team for help first.

Call: 1-800-489-3351 (toll free)

Monday-Friday 9am - 5pm CST

Visit: www.ameriwoodhome.com

WARNING

- Unit can tip over causing severe injury or death.
- Anchor unit to stud in wall (if instructed to).
- Do Not allow children to climb on unit.
- Put heavy items on lower shelves or drawers.

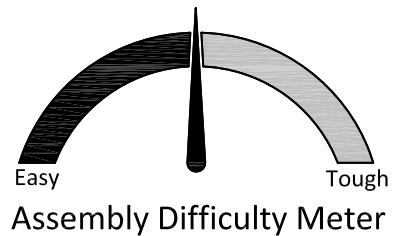

Follow Ameriwood Home



Contact Us!

Do NOT return this product!

Contact our friendly customer service team first for help.



Visit ameriwoodhome.com

Assembly Tips



Helpful Hints

PEOPLE NEEDED FOR ASSEMBLY: **1-2**
ESTIMATED ASSEMBLY TIME: **1 HOUR**

- Open your item in the area you plan to keep it to avoid excessive heavy lifting.
- Identify, sort and count the parts before attempting assembly.
- Compression dowels are lightly tapped in with a hammer.
- Slides are labeled with a **R** (right) and **L** (left) for proper placement.
- Make sure to always face the point on the top of the Cam Lock towards the outer edge.
- Use all the nails provided for the back panel and spread them out equally.
- Back panel must be used to make sure your unit is sturdy.
- Do NOT use harsh chemicals or abrasive cleaners on this item.
- Never push, pull, or drag your furniture.

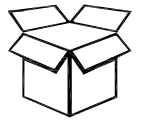

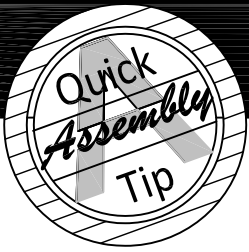

Before You Start

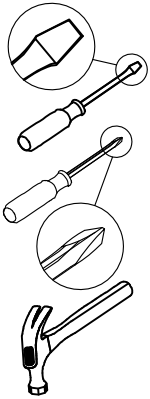

- ✓ Read through each step carefully and follow the proper order
- ✓ Separate and count all your parts and hardware
- ✓ Give yourself enough room for the assembly process
- ✓ Have the following tools: Flat Head Screwdriver, #2 Phillips Head Screwdriver and Hammer
- ✓ Caution: If using a power drill or power screwdriver for screwing, please be aware to slow down and stop when screw is tight. Failure to do so may result in stripping the screw.

Cam Lock Fastening System

This Cam Lock Fastening System will be used throughout the assembly process.

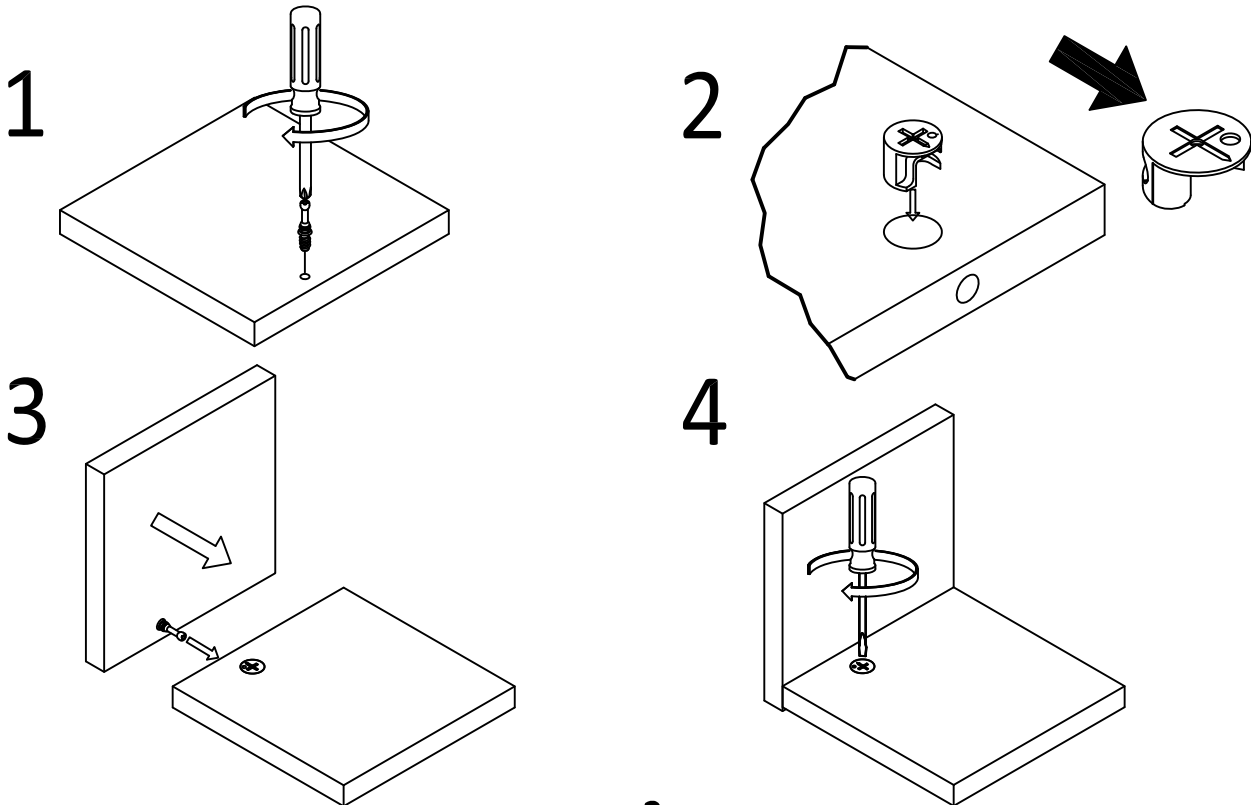

Board Identification

Not Actual Size

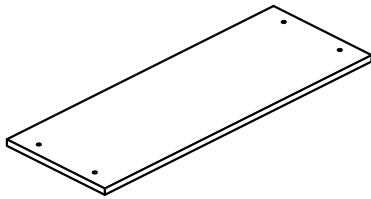

A

Shelf
T7031872010KX
QTY:2 PCS

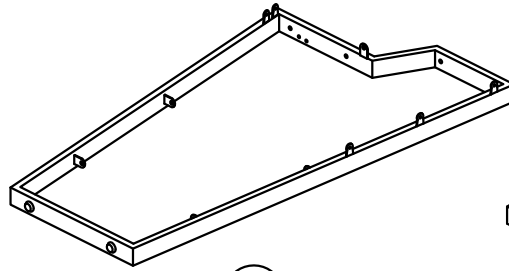

B

Left leg frame
T7031872020KX

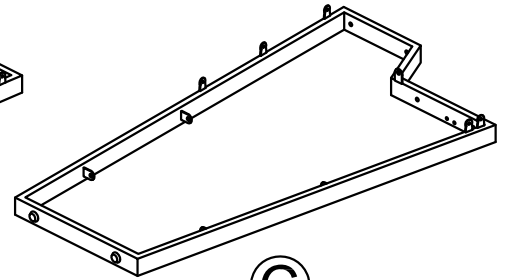

C

Right leg frame
T7031872030KX

Preassembled parts

Left leg frame	T7031872021KX
Adjustable foot Ø19 (2)	TKX1267

Preassembled parts

Right leg frame	T7031872031KX
Adjustable foot Ø19 (2)	TKX1267

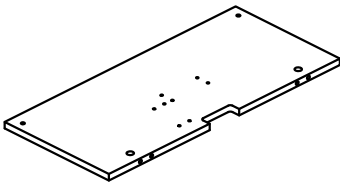

D

Upper shelf
T7031872040KX

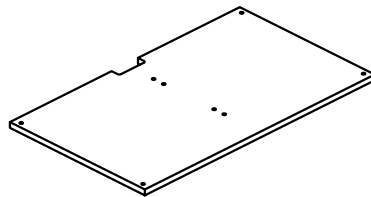

E

Lower shelf
T7031872050KX

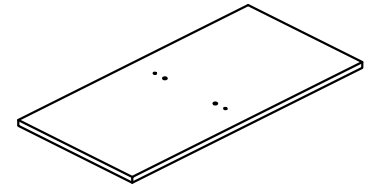

F

Bottom shelf
T7031872060KX

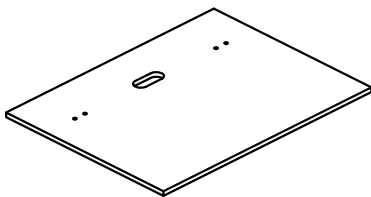

G

Back panel
T7031872070KX

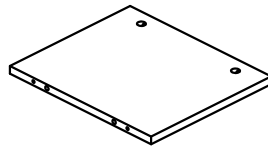

H

Partition
T7031872080KX

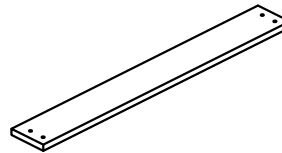

I

Apron
T7031872090KX

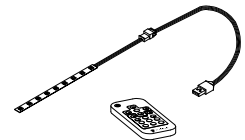

J

LED light
T7031872100KX

Preassembled Parts

LED light	T7031872101KX
Remote	T7031872102KX

Board Identification

Not actual size

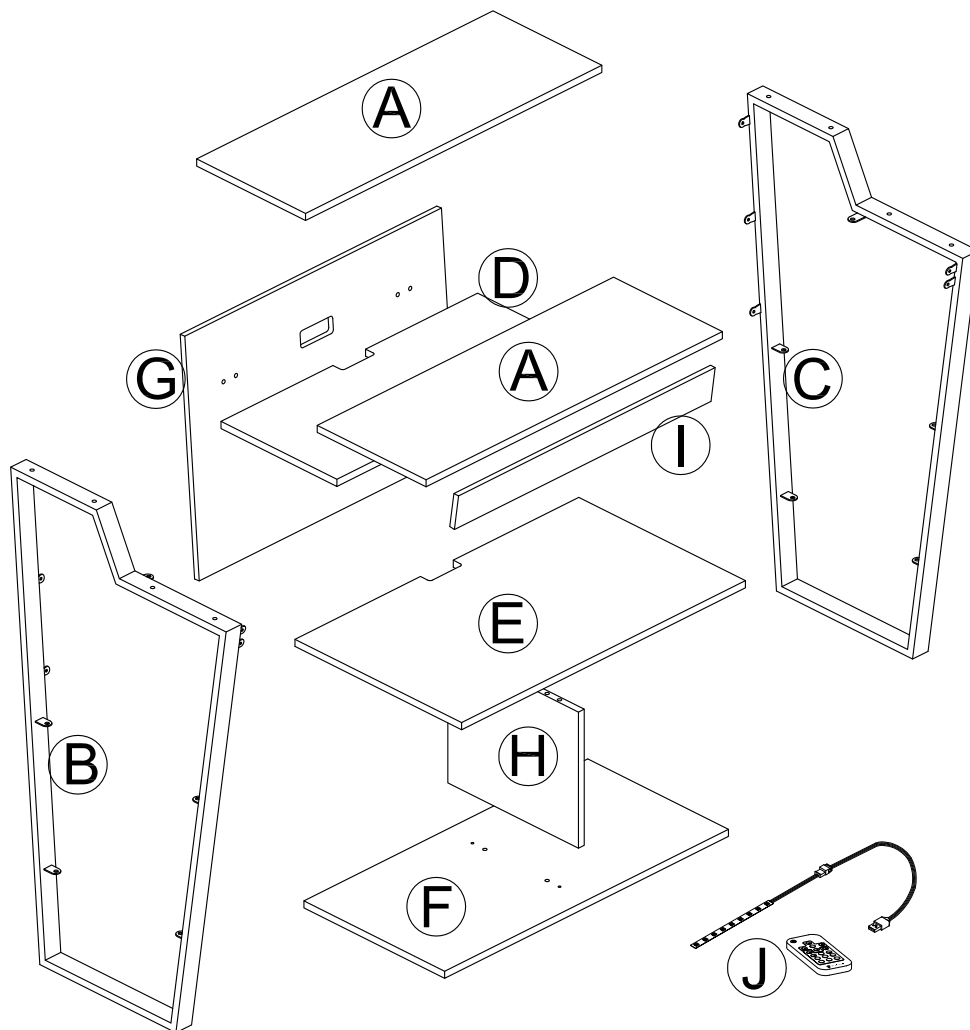

Part List

Actual Size

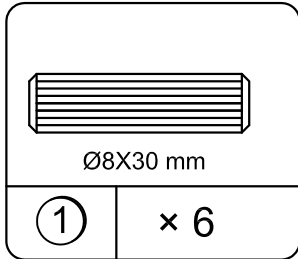

Wood dowel
TKX1005

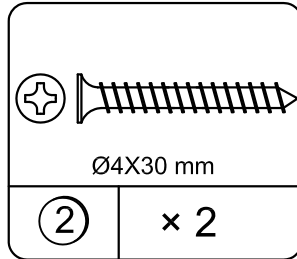

Screw
TKX1070

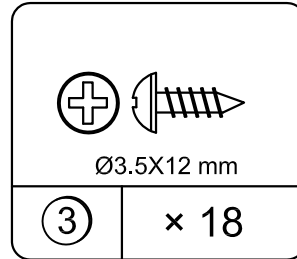

Screw
TKX1016

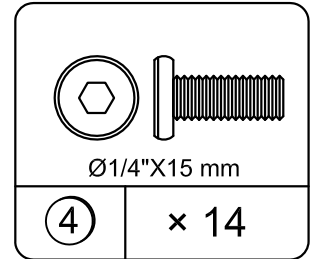

Bolt
TKX1090

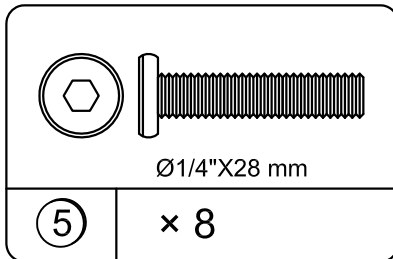

Bolt
TKX1238

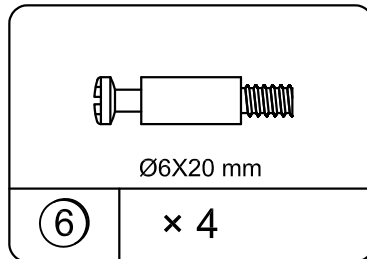

Cam bolt
TKX1270

Part List

Not Actual Size

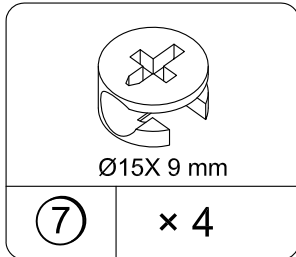

Cam lock
TKX1023

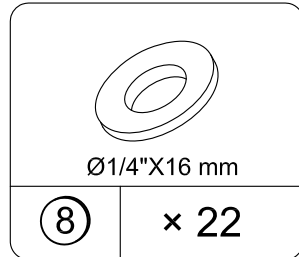

Washer
TKX1003

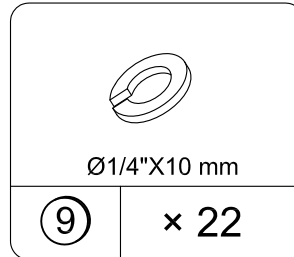

Spring washer
TKX1002

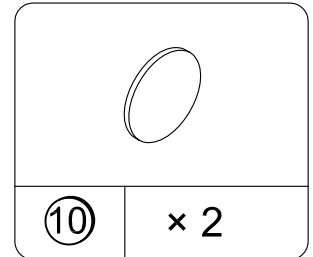

Cam cover
TKX1065

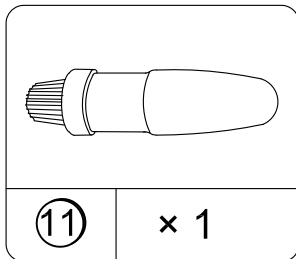

Glue
TKX1014

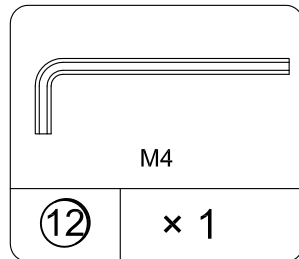

Hex key
TKX1004

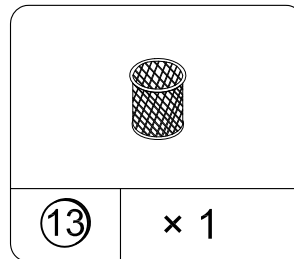

Metal mesh cup
TKX1119

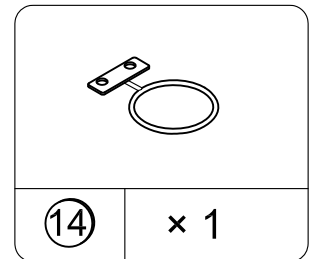

Cup holder
TKX1333

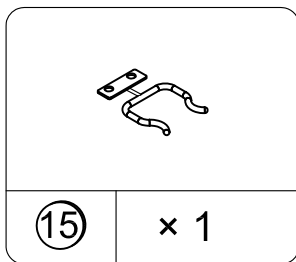

Headphone holder
TKX1334

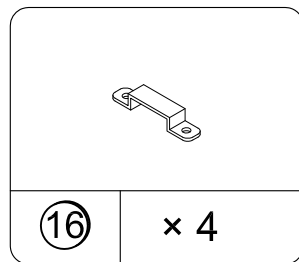

Wire clip
TKX1111

STEP 1

NTENSE

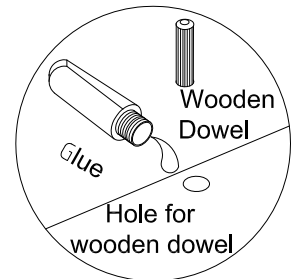
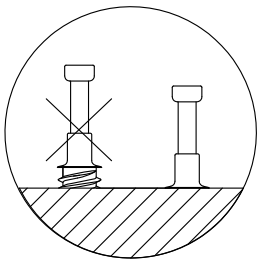
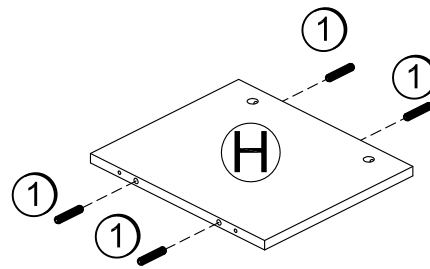
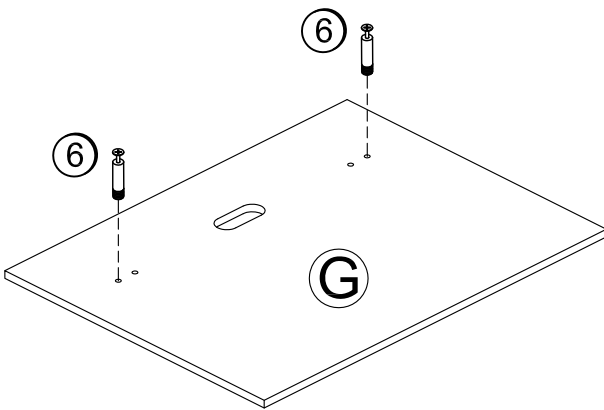
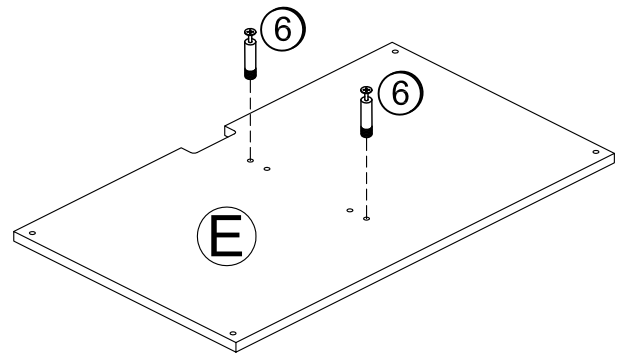
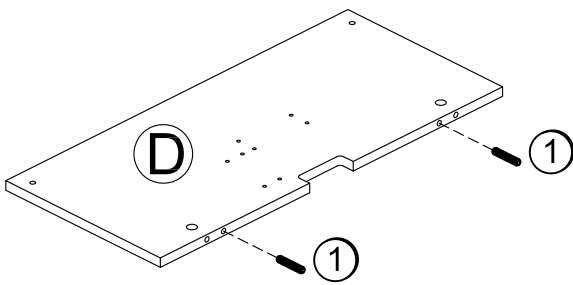
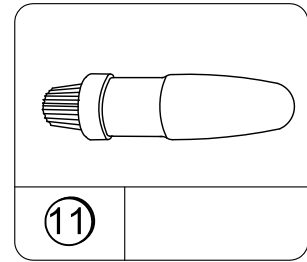
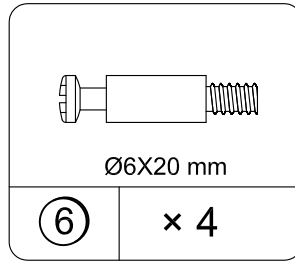
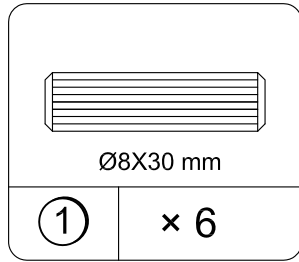
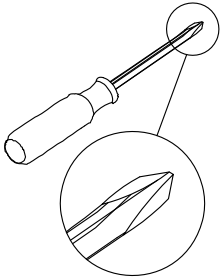

Use one drop of glue in dowel hole.

STEP 2

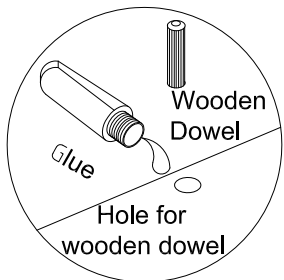
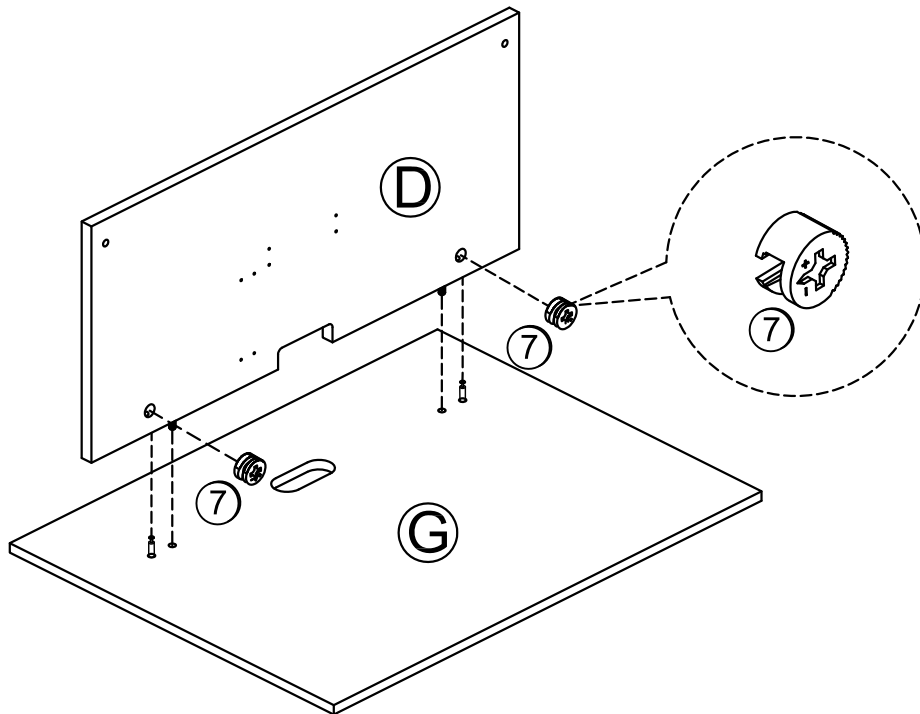
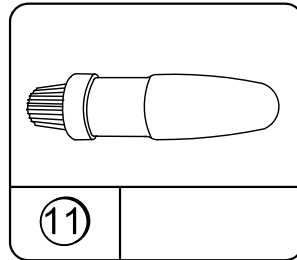
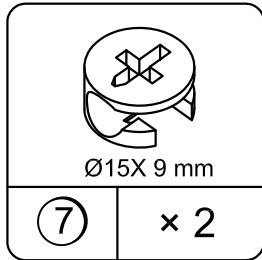
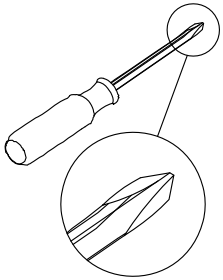

Use one drop of glue
in dowel hole.

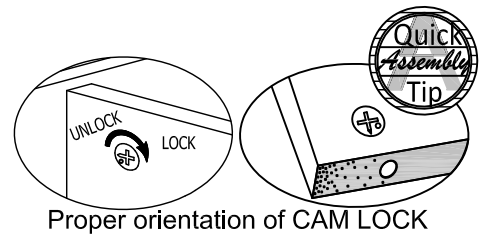

STEP 3

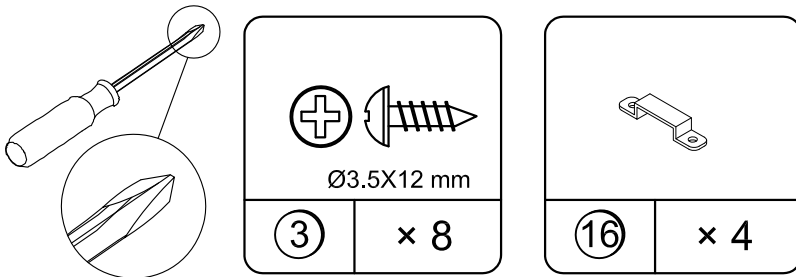

Install LED light as below illustration.

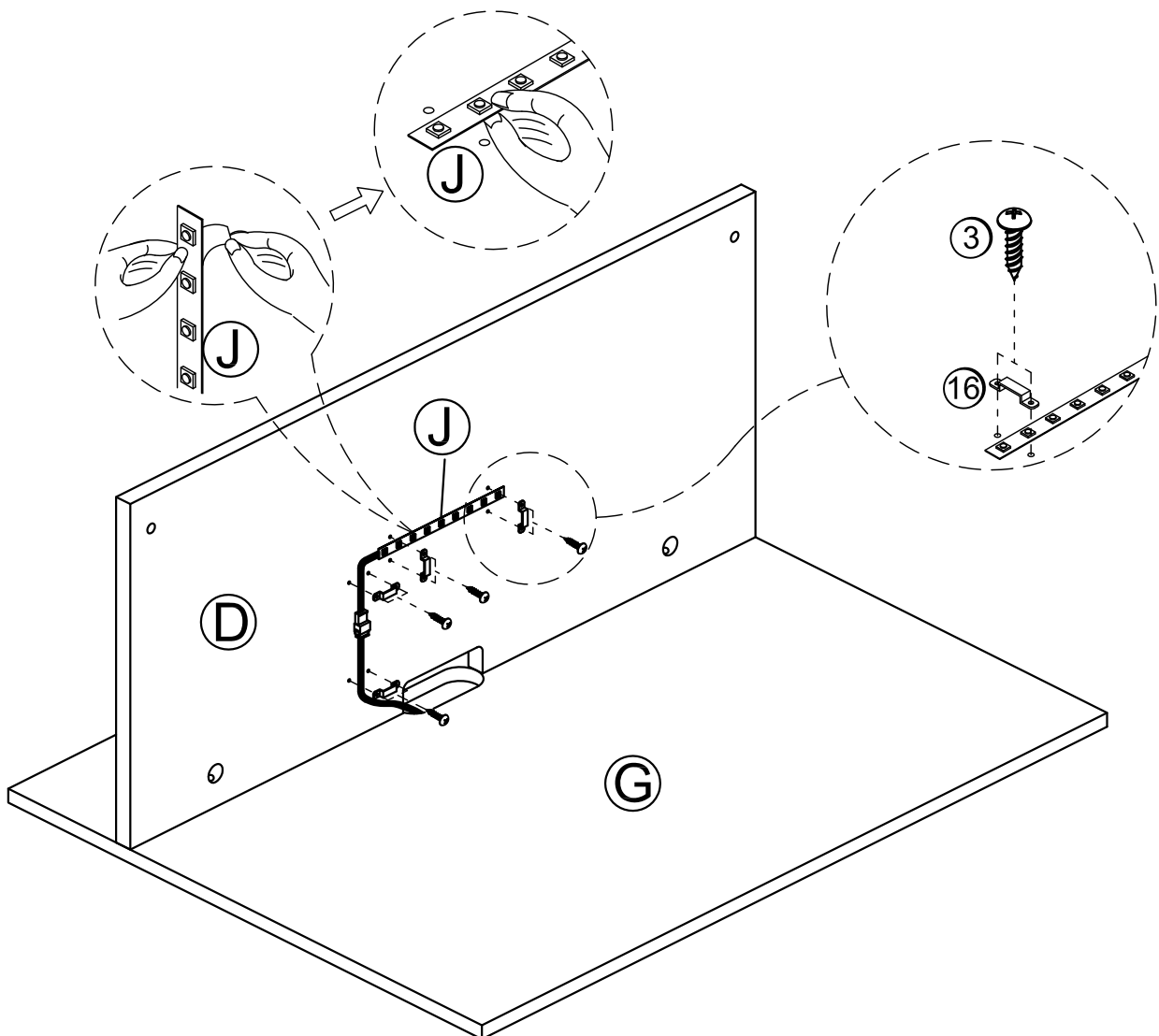

STEP 3

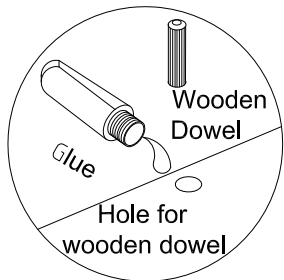
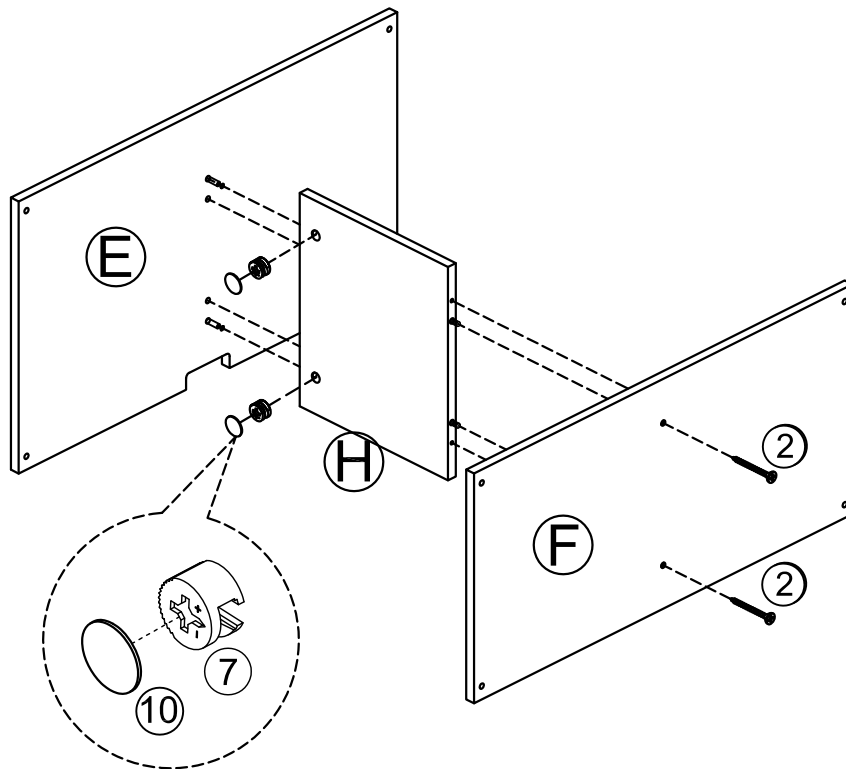
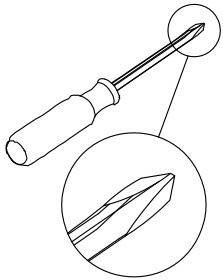
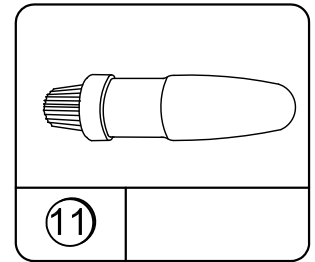
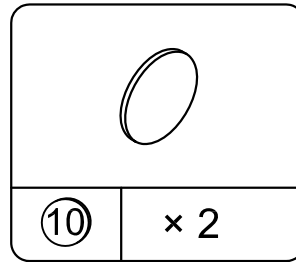
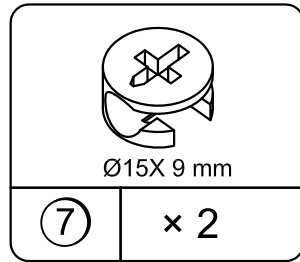
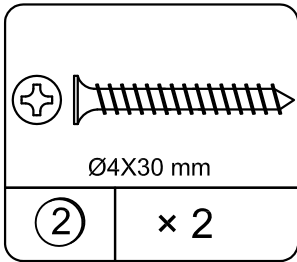

Use one drop of glue in dowel hole.

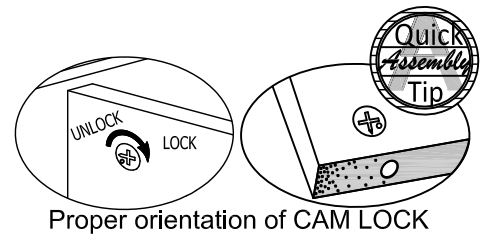

STEP 4

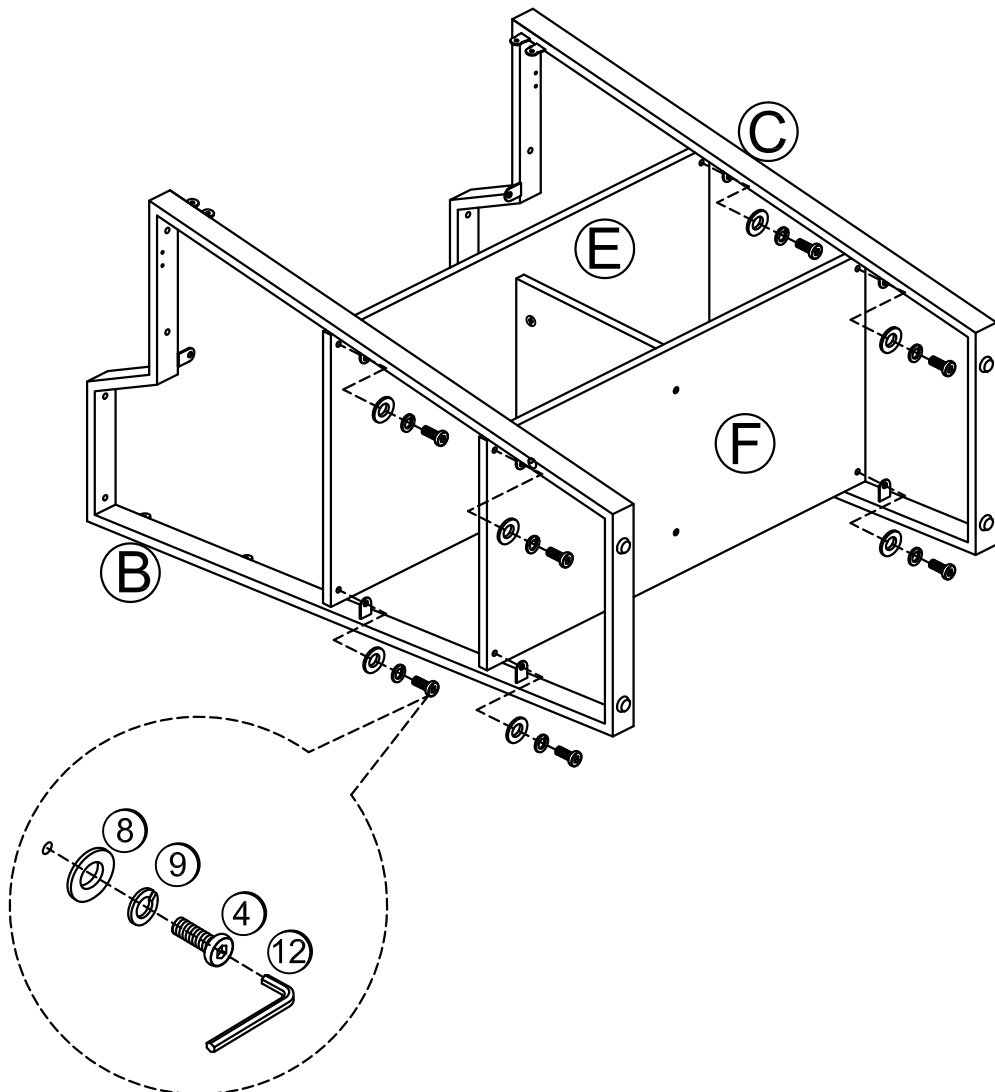
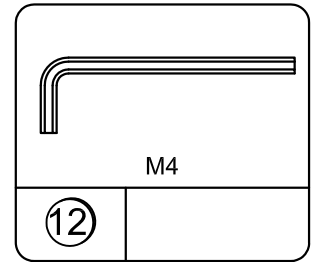
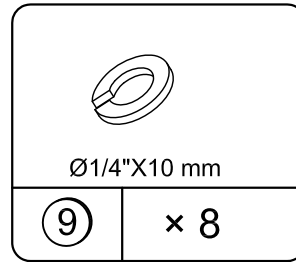
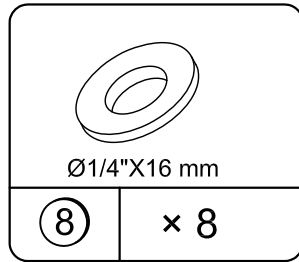
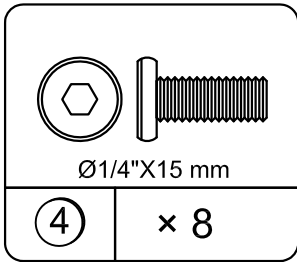

Note: DO NOT tighten the bolt to ensure the assembly successfully in this step.

STEP 5

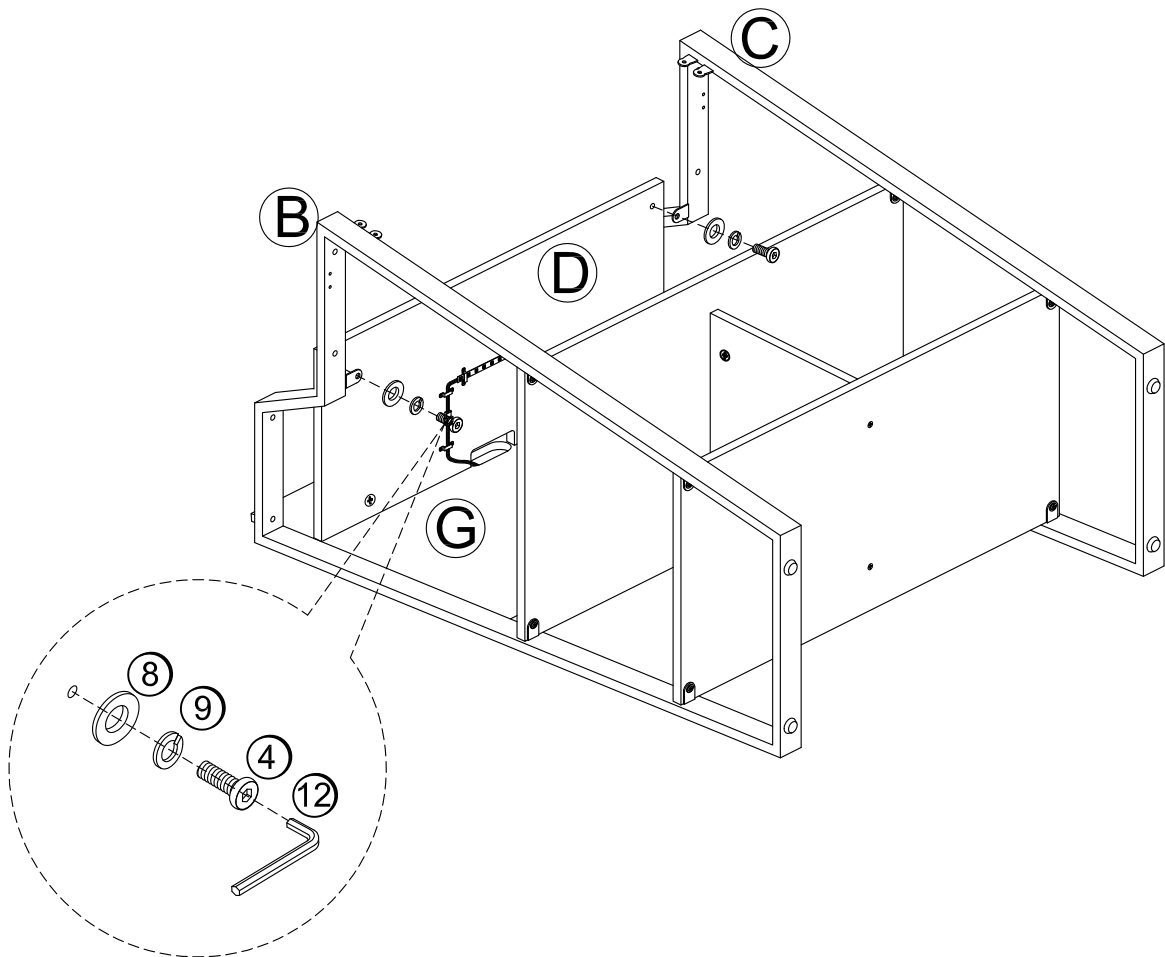
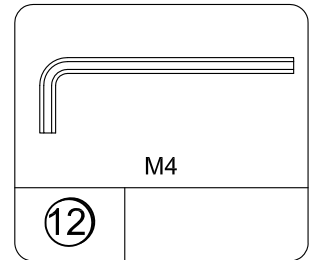
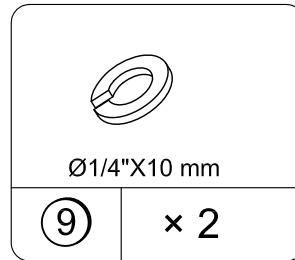
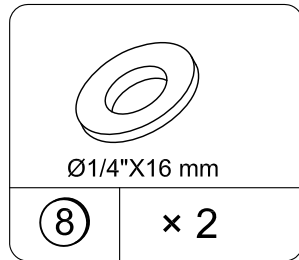
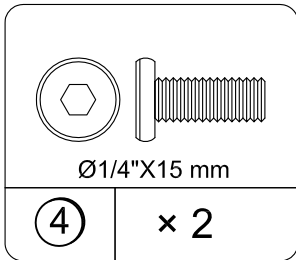

Note: DO NOT tighten the bolt to ensure the assembly successfully in this step.

STEP 6

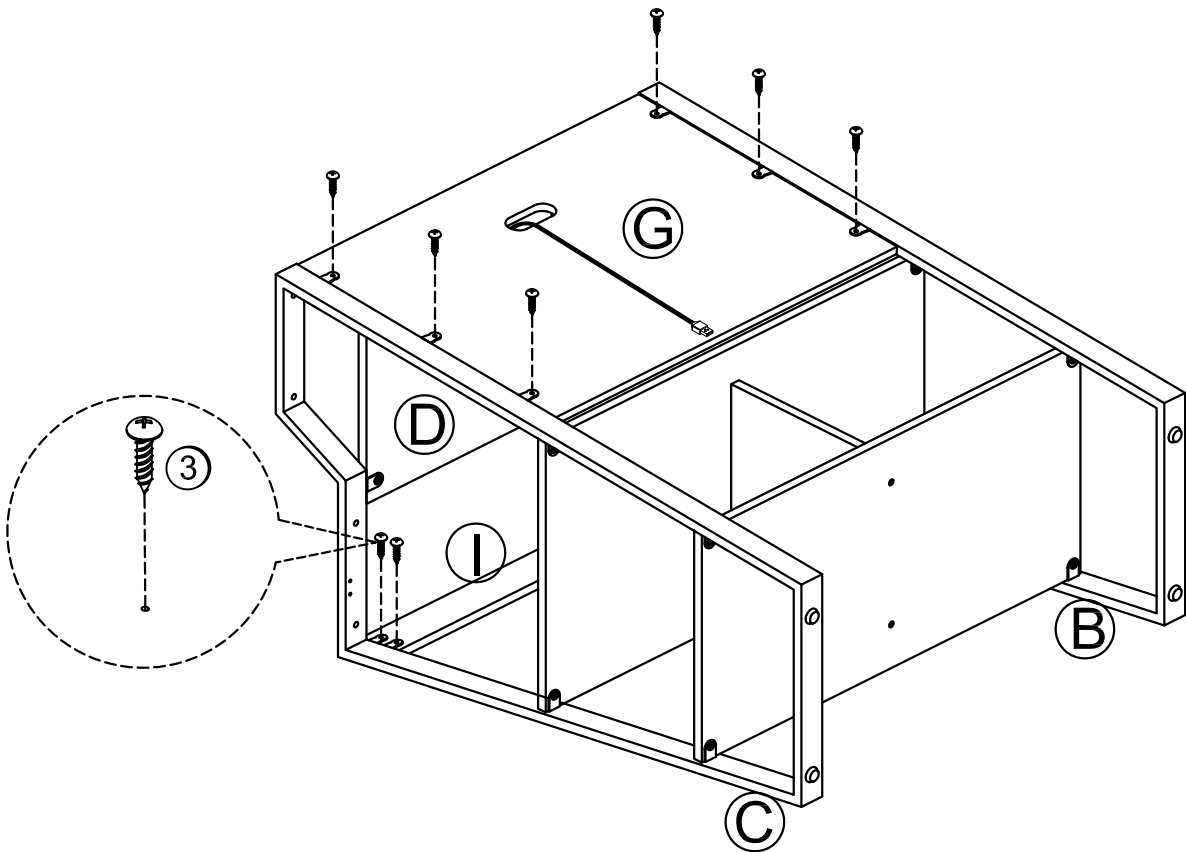
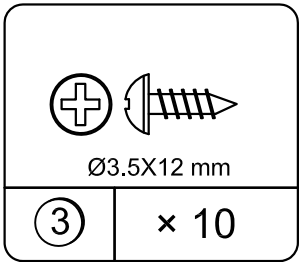
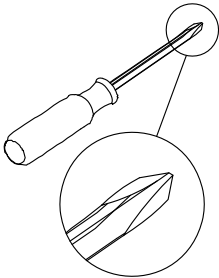

STEP 7

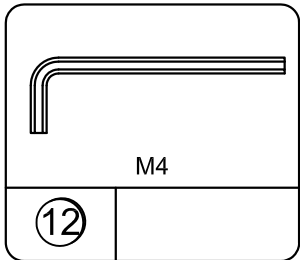
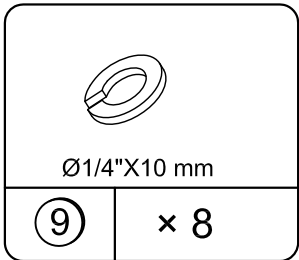
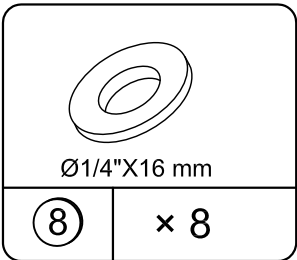
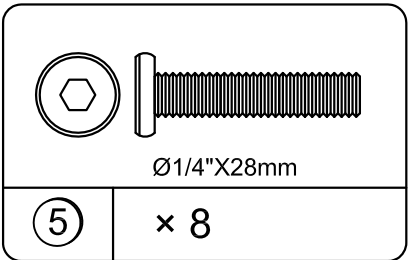

If the ground is uneven, adjust the foot levelers by rotating them to your preferred height. Once the stand is standing and the levelers are adjusted, make sure the unit does not wobble.

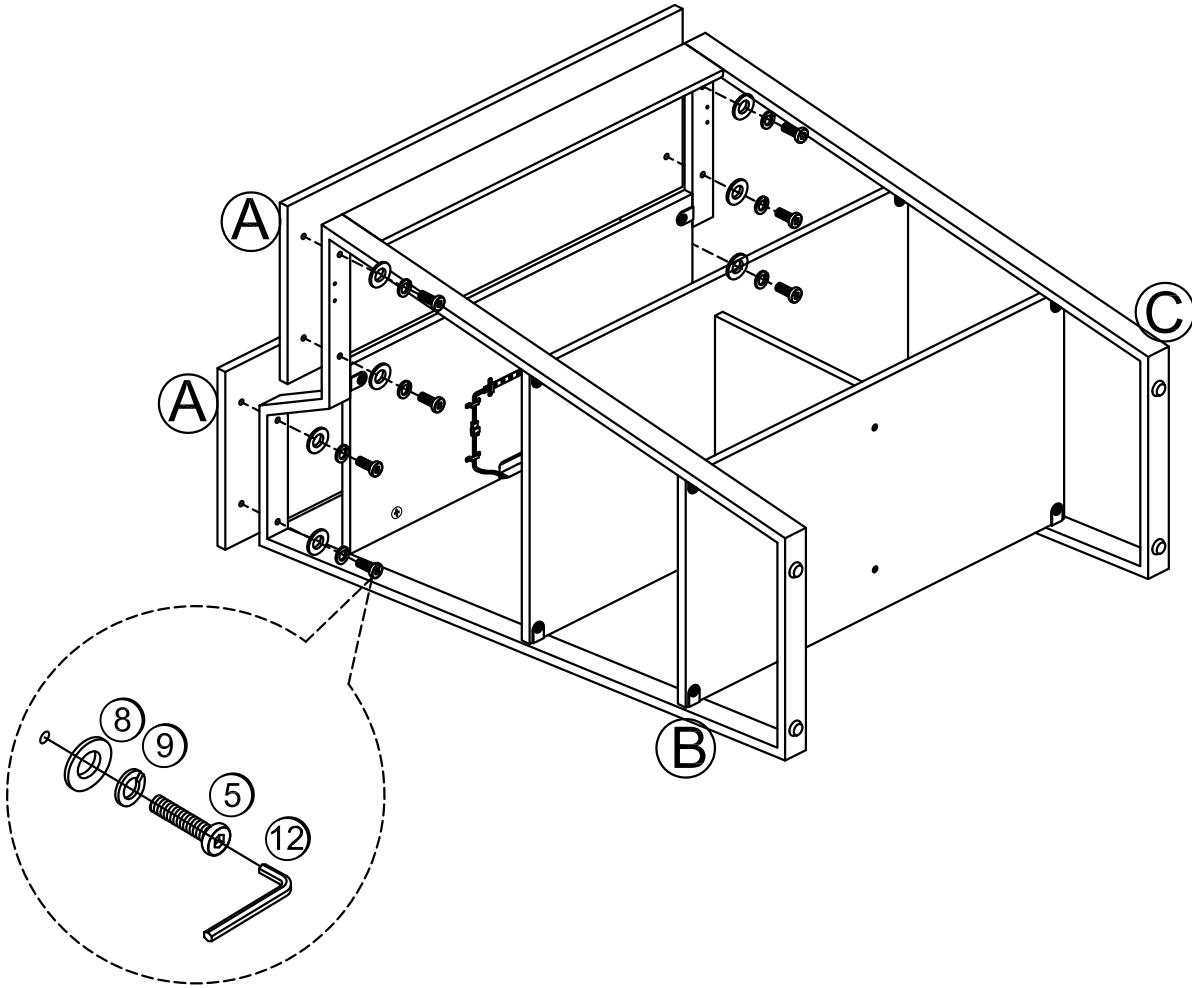

Note: Tighten all bolts to secure the unit in this assembly step.

STEP 8

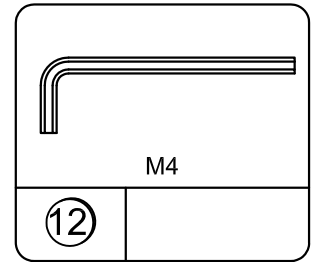
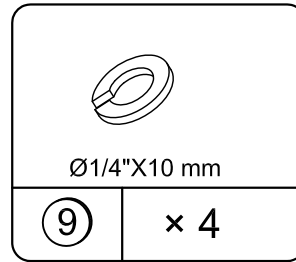
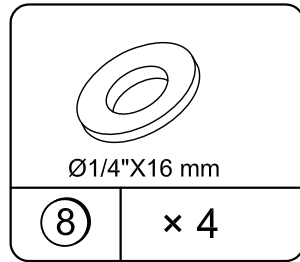
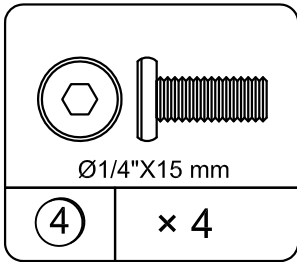

You have 2 options to install the cup holder and headphone holder.
Option 1:

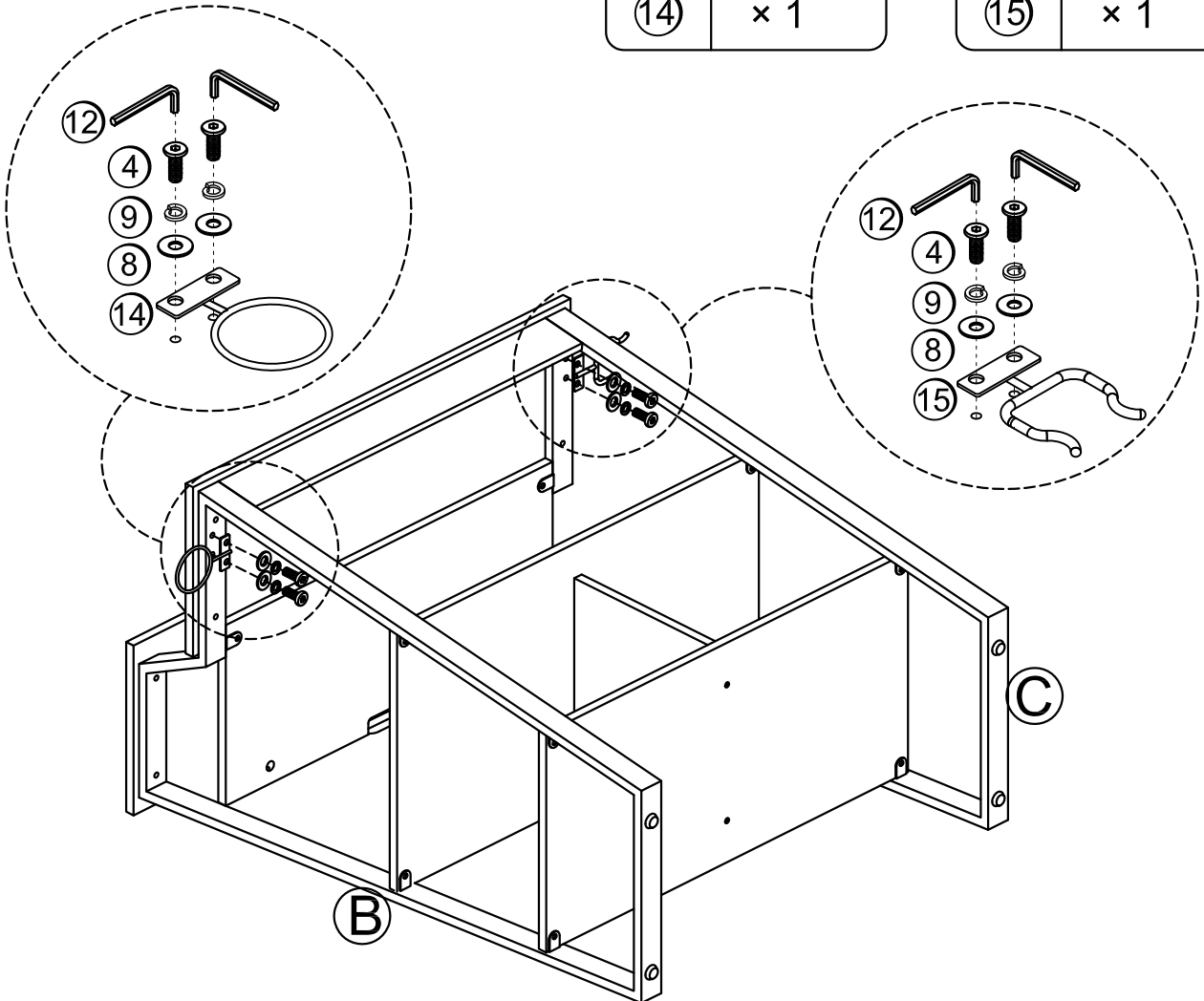
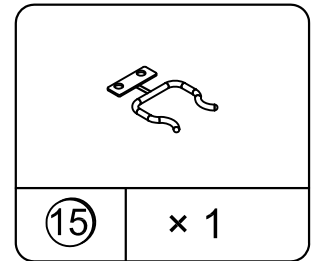
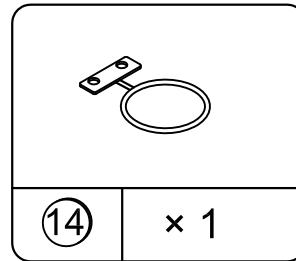

STEP 9

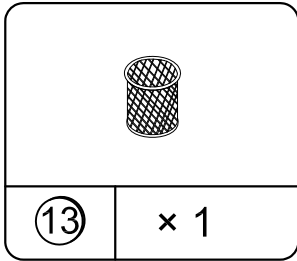

You have 2 options to install the cup holder and headphone holder.
Option 1:

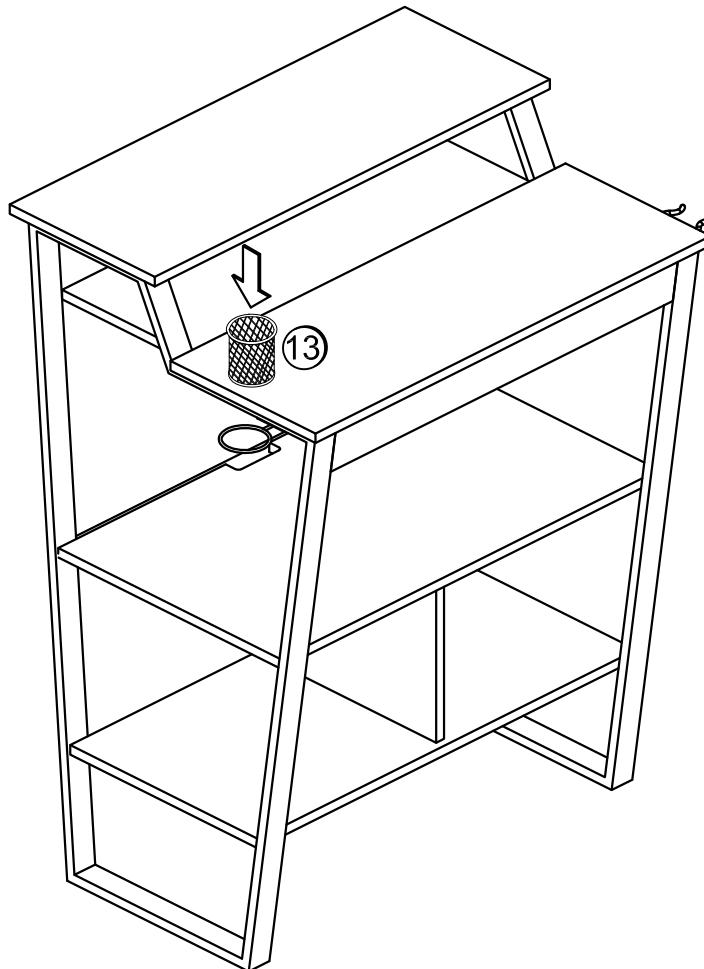

STEP 10

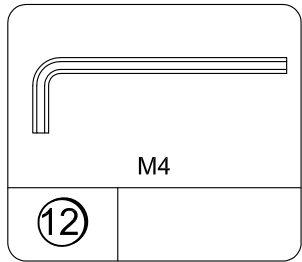
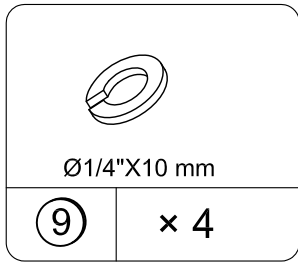
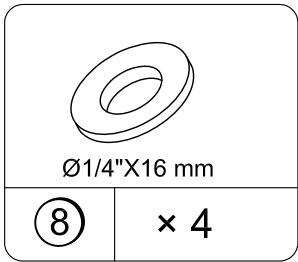
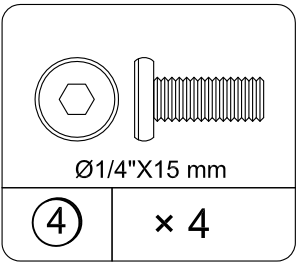

You have 2 options to install the cup holder and headphone holder.

Option 2:

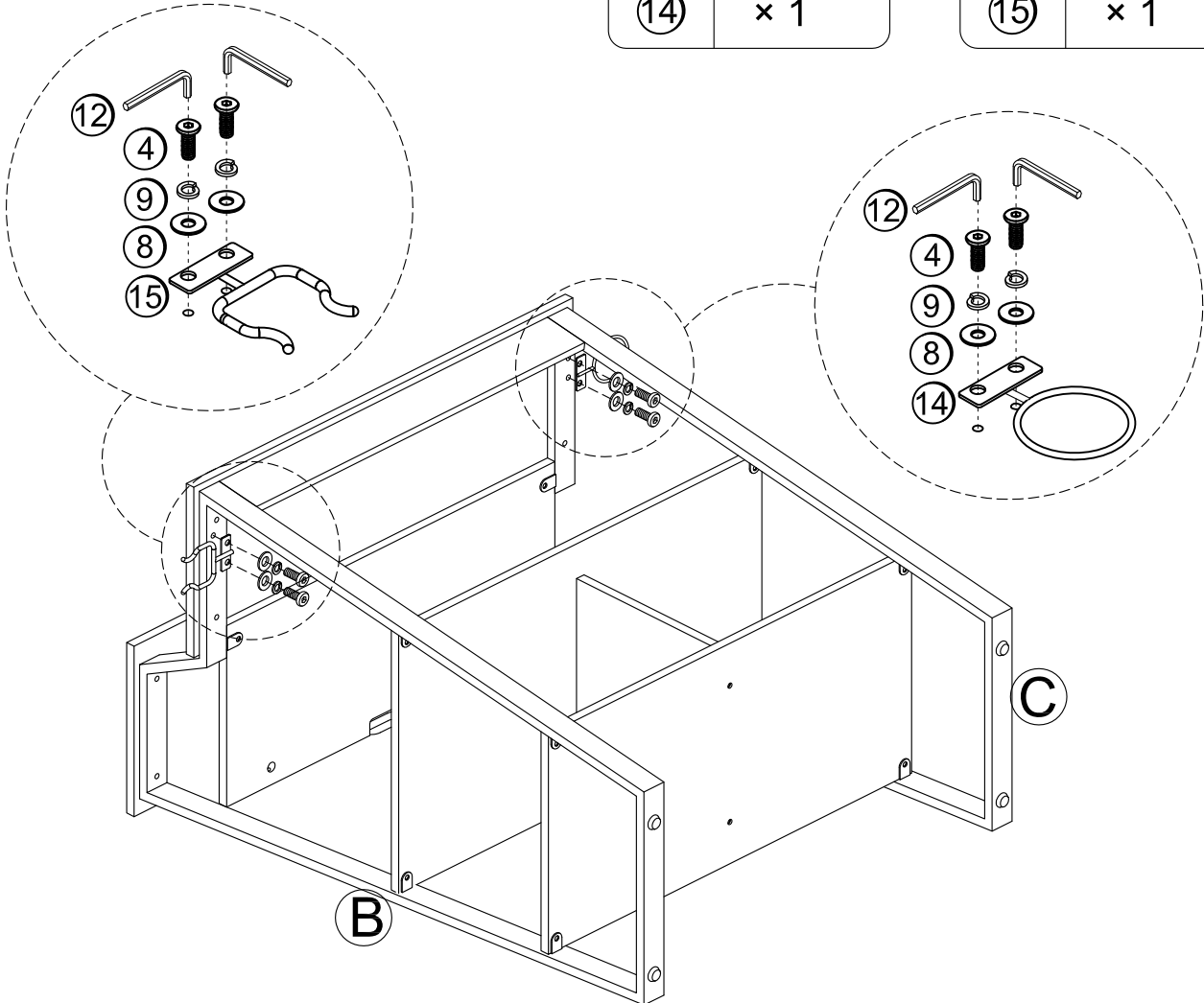
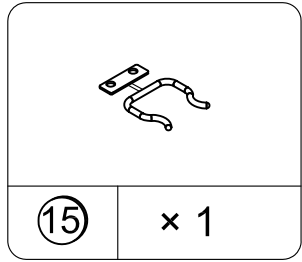
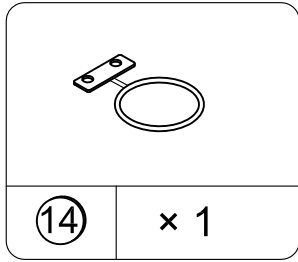

STEP 11

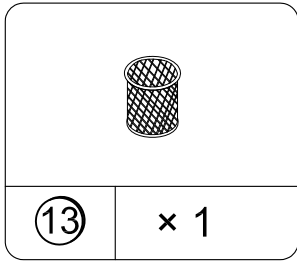

You have 2 options to install the cup holder and headphone holder.
Option 2:



Maximum Loads

This unit has been designed to support the maximum loads shown. Exceeding these load limits could cause sagging, instability, product collapse, and/or serious injury.

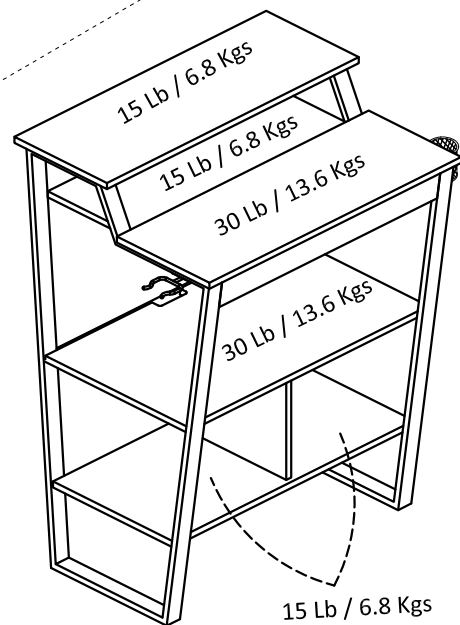
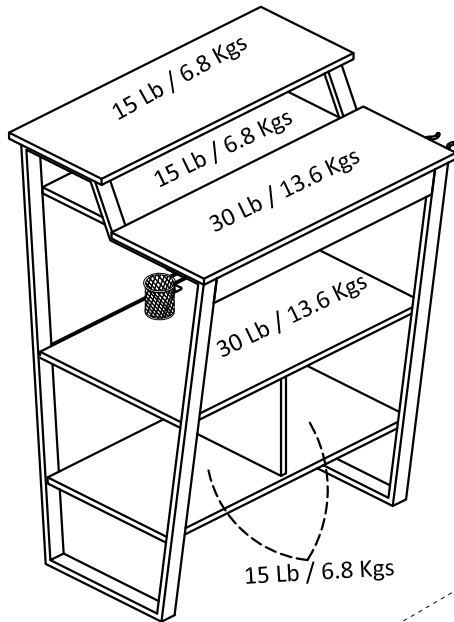

Warning: Risk of injury to persons - do not place a television on this furniture. This furniture is not approved for use with a television.

Certificate of Conformity

1. This certificate applies to the Dorel Home Furnishings, Inc. product identified by this instruction manual.
2. This certificate applies to compliance of this product with the CPSC Ban on Lead-Containing Paint (16 CFR 1303).
3. This product is distributed by: Dorel Home Furnishings, Inc.
410 East First Street South
Wright City, MO 63390
636-745-3351
4. Site of Manufacture: Svay Rieng, Cambodia
5. See front page of instruction manual for date of manufacture.

Register your product to receive the following:



- * New trend details - sneak peek on what's new
- * Surveys - have a voice within our community
- * Exclusive deals and discount codes
- * Quick and easy replacement part service

To register your product, visit ameriwoodhome.com

Star Rating



Visit your local retailer's website, rate your purchased product and leave us some feedback!

We would like to extend a big "Thank You" to all of our customers for taking the time to assemble this Ameriwood Home product, and to give us your valuable feedback.

Thank You!

Cubierta Delantera

Este libro de instrucciones contiene información **IMPORTANTE** de seguridad. Por favor lea y manténgalo para referencia en el futuro.

No Regrese este producto! Comuníquese con nuestro amistoso equipo de servicio al cliente para obtener ayuda.

Llámenos al: 1-800-489-3351 (Gratis) Lunes - Viernes 9am - 5pm CST

Visitar: www.ameriwoodhome.com

PRECAUCION

Este mueble puede volcarse y causar graves heridas y/o muerte.

Anclar el mueble a un poste de madera en la pared (si esto se requiere).

No Permita que los niños monten el mueble.

Mantenga los artículos más pesados en los cajones de abajo.

Consejos Útiles (página 2)

- Abra su artículo en el área donde usted planea utilizarlo para evitar levantar y moverlo menos
- Identificar, ordenar y contar las piezas antes de intentar ensamblar
- Las clavijas de compresión se golpean con un martillo
- Las diapositivas están marcadas con una R (derecha) y L (izquierda) para la colocación correcta
- Asegúrese de que siempre este el punto localizado en la parte superior de bloqueador de leva este volteado hacia borde exterior
- Utilizar todos los clavos para el panel de atrás y distribuirlos por igual
- El panel de atrás debe utilizarse para asegurarse de que la unidad quede fija y firme
- No use químicas fuertes ni limpiadores abrasivos en este artículo
- Nunca empuje, tire ni arrastre los muebles

Antes de Que Empieces (página 3)

- Lea cuidadosamente cada paso y siga el orden correcto

- Separar y contar todas sus piezas y hardware

- Dése suficiente espacio para el proceso de ensamble

- Tenga las siguientes herramientas: destornillador de cabeza plana, #2 cabeza Phillips

Destornillador y martillo

- Precaución: Si usa un taladro electrónico o un destornillador eléctrico para atornillar, por favor asegúrese que deje de atornillar cuando el tornillo este apretado. Fallar hacer esto puede causar barrer el tornillo.

Sistema de fijar el bloqueo de leva (página 3)

Este sistema de fijar el bloqueo de leva será usado en todo el proceso ensamble.

Identificación de los Paneles (Página 4)

- Este no es el tamaño real
- (A) Repisa
 - (B) Marco de pata izquierda
 - (C) Marco de pata derecha
 - (D) Repisa superior
 - (E) Repisa inferior
 - (F) Repisa inferior
 - (G) Panel trasero
 - (H) Partición
 - (I) Embellecedor
 - (J) Luz LED

Lista de Piezas (Página 6)

- Tamaño real
- (1) Clavija de madera
 - (2) Tornillo
 - (3) Tornillo
 - (4) Tornillo
 - (5) Tornillo
 - (6) Tornillo de rosca

Lista de Piezas (Página 7)

- Este no es el tamaño real
- (7) Tornillo de cerradura
 - (8) Arandela
 - (9) Arandela de resorte
 - (10) Tapa de la leva
 - (11) Pegamento
 - (12) Llave en L
 - (13) Copa de malla metálica
 - (14) Portavasos
 - (15) Soporte para auriculares
 - (16) Sujetador de alambre

Página 8

Agujero para clavija de madera. Use una gota de pegamento en el agujero de clavija.

Página 9

Agujero para clavija de madera. Use una gota de pegamento en el agujero de clavija.

Página 10

Instale la luz LED como se muestra abajo.

Página 11

Agujero para clavija de madera. Use una gota de pegamento en el agujero de clavija.

Página 12

Nota: NO APRIETE el perno para asegurar un ensamblaje exitoso en este paso.

Página 13

Nota: NO APRIETE el perno para asegurar un ensamblaje exitoso en este paso.

Página 15

Si el suelo está disparejo, ajuste los niveladores de pata girándolos a la altura requerida. Cuando el mueble está de pie y los niveladores están ajustados, asegúrese de que la unidad no se tambalee.

Nota: Apriete todos los pernos para estabilizar la unidad en este paso.

Página 16, 17, 18, 19

Tiene 2 opciones para instalar el portavasos y el portauriculares.

Página 20

CARGA MAXIMA

Esta unidad ha sido diseñada para soportar la carga máxima anotada. El exceder estos límites puede causar inestabilidad, colapsarse y/o causar serias lesiones.

ADVERTENCIA: Riesgo de lesiones a las personas - no coloque un televisor sobre muebles. Este mueble no está aprobado para su uso con un televisor.

Página 21

Registre su producto para recibir lo siguiente:

- * Detalles de nuevas tendencias - Vistazo a lo nuevo
- * Encuestas - alec su voz entre su comunidad
- * Códigos de ofertas y descuentos exclusivos
- * Fácil y rápido servicio de partes de remplace

Para registrar su producto, visite ameriwoodhome.com

Clasificación de 5 estrellas

Visite el sitio web de su tienda local, califique su comprado y denos sus comentarios!

Nos gustaría enviar un gran "Agradecimiento" a todos nuestros clientes por tomarse el tiempo de ensamblar este producto de Ameriwood Home, y por darnos sus valiosos comentarios.

Gracias

Français

Couverture Avant

CE LIVRET D'INSTRUCTION CONTIENT DES INFORMATIONS IMPORTANTES SUR LA SÉCURITÉ. VEUILLEZ LIRE ET GARDER POUR UNE RÉFÉRENCE FUTURE

Ne retournez pas ce produit! Contactez notre équipe de service à la clientèle amicale d'abord pour obtenir de l'aide.

Appelez-nous: 1-800-489-3351 (sans frais) du Lundi au Vendredi de 9h à 17h Heure Centrale

Visitez: www.ameriwoodhome.com

ATTENTION

Le meuble peut basculer et causer des blessures graves ou la mort.

Ancrer le meuble à une planche murale dans le mur (si indiqué).

Ne laissez pas les enfants grimper sur le meuble.

Placez les articles lourds sur les étagères ou dans les tiroirs inférieurs.

Astuces Utiles (page 2)

-Ouvrez votre article dans la zone que vous prévoyez de le garder pour moins de levage lourd

-Identifier, trier et compter les pièces avant d'essayer d'assembler

-Les goujons de compression sont taraudés avec un Marteau

-Les glissières sont marquées d'un R (droit) et d'un L (gauche) pour un bon placement

-Assurez-vous toujours de faire face la pointe situé sur le haut de la Serrure de Came vers le bord extérieur

-Utiliser tous les clous fournis pour le panneau arrière et les répartir également

-Le panneau arrière doit être utilisé pour vous assurer que votre appareil est robuste

-N'utilisez pas de produits chimiques agressifs ou de nettoyeurs abrasifs sur cet appareil

-Ne jamais pousser, tirer, ou faire glisser votre meuble

Avant de Commencer (page 3)

-Lisez attentivement chaque étape et suivez le bon ordre

-Séparez et comptez toutes vos pièces et matériaux

-Donnez-vous suffisamment de place pour l'assemblage

-Avoir les outils suivants: tournevis à tête plate, #2 tournevis Phillips, et Marteau

-Attention: Si vous utilisez une perceuse électrique ou un tournevis électrique pour visser, veillez à ralentir et arrêter lorsque la vis est bien serrée. Le non-respect de cette consigne peut endommager la vis.

Système de Fixation de Came (page 3)

Ce Système de Fixation de Came sera utilisé tout au long de l'assemblage

Identification des matériaux (Page 4)

- Pas de taille réelle
- (A) Tablette
- (B) Patte gauche
- (C) Patte droite
- (D) Réglable supérieur
- (E) Tablette inférieur
- (F) Tablette Inférieure
- (G) Panneau arrière
- (H) Cloison
- (I) Tablier
- (J) Lumière DEL

Liste des pièces (Page 6)

- Taille réelle
- (1) Goujon en bois
- (2) Vis
- (3) Vis
- (4) Boulon
- (5) Boulon
- (6) Boulon de came

Liste des pièces (Page 7)

- Pas de taille réelle
- (7) Serrure de came
- (8) Rondelle
- (9) Rondelle à ressort
- (10) Abri de la came
- (11) Colle
- (12) Clé hexagonale
- (13) Gobelet en filet métallique
- (14) Porte-gobelet
- (15) Support pour casque d'écoute
- (16) Pince à fil

Page 8

Trou pour cheville en bois. Utilisez une goutte de colle dans le trou de la cheville.

Page 9

Trou pour cheville en bois. Utilisez une goutte de colle dans le trou de la cheville.

Page 10

installez la lumière LED comme indiqué dans l'illustration ci-dessous

Page 11

Trou pour cheville en bois. Utilisez une goutte de colle dans le trou de la cheville.

Page 12

Note: NE PAS serrer le boulon complètement à cette étape pour faciliter l'assemblage.

Page 13

Note: NE PAS serrer le boulon complètement à cette étape pour faciliter l'assemblage.

Page 15

Si le sol est inégal, ajustez les niveleurs de pied en les faisant tourner à votre hauteur préférée. Une fois que le meuble est debout et que les niveleurs sont ajustés, assurez-vous que l'unité ne vacille pas

Note: Serrez tous les boulons à cette étape pour bien fixer l'unité.

Page 16, 17, 18, 19

Vous avez 2 options pour installer le porte-gobelet et le porte-casque.

Page 20

CHARGES MAXIMALES

Ce meuble a été conçu pour supporter les charges maximales indiquées. En excédant ces limites de charge, le meuble pourrait devenir instable, s'effondrer, et/ou causer des blessures graves.

AVERTISSEMENT : Risque de blessure corporelle - ne pas placer une télévision sur ce meuble. Ce meuble n'est pas approuvé pour une utilisation avec une télévision.

Page 21

Enregistrez votre produit pour recevoir les éléments suivantes:

- * Détails sur les nouvelles tendances - un aperçu sur les nouveautés
- * Sondages - avoir une voix au sein de notre communauté
- * Offres exclusives et codes promo
- * Service de pièces de rechange rapide et facile

Pour enregistrer votre produit, visitez ameriwoodhome.com

5 Étoiles

Visitez le site Web de votre détaillant local, évaluez votre produit acheté et laissez-nous quelques commentaires !

Nous tenons à offrir un grand "Merci" à tous nos clients pour avoir pris le temps d'assembler ce produit "Ameriwood Home", et de nous donner vos commentaires précieux.

Merci