

9323013COM Coffee Table-White

Ameriwood
HOME

Date of Purchase ___ / ___ / ___
Lot Number:

B349323013COM00SF

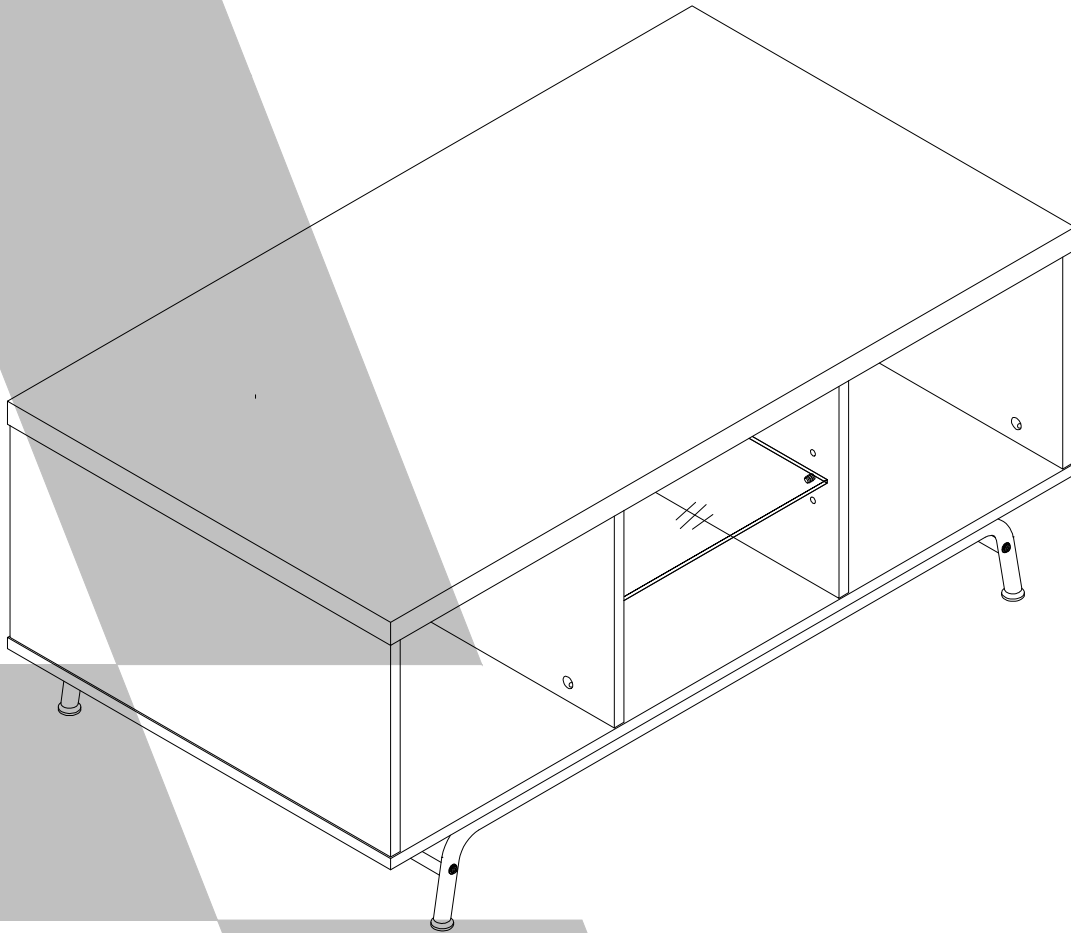

THIS INSTRUCTION BOOKLET CONTAINS **IMPORTANT** SAFETY INFORMATION. PLEASE READ AND KEEP FOR FUTURE REFERENCE.

Do Not Return This Product!

Contact our customer service team for help first.

Call: 1-800-489-3351 (toll free)

Monday-Friday 9am - 5pm CST

Visit: www.ameriwoodhome.com

WARNING

- Unit can tip over causing severe injury or death.
- Anchor unit to stud in wall (if instructed to).
- Do Not allow children to climb on unit.
- Put heavy items on lower shelves or drawers.

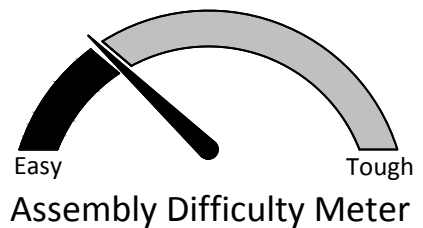

Follow Ameriwood Home



Contact Us!

Do NOT return this product!

Contact our friendly customer service team first for help.

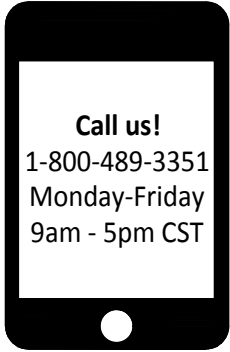

Visit ameriwoodhome.com

Assembly Tips



Helpful Hints

PEOPLE NEEDED FOR ASSEMBLY: 2

ESTIMATED ASSEMBLY TIME: 1 HOUR

- Open your item in the area you plan to keep it to avoid excessive heavy lifting.
- Identify, sort and count the parts before attempting assembly.
- Compression dowels are lightly tapped in with a hammer.
- Slides are labeled with a **R** (right) and **L** (left) for proper placement.
- Make sure to always face the point on the top of the Cam Lock towards the outer edge.
- Use all the nails provided for the back panel and spread them out equally.
- Back panel must be used to make sure your unit is sturdy.
- Do NOT use harsh chemicals or abrasive cleaners on this item.
- Never push, pull, or drag your furniture.



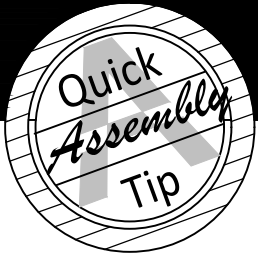

Before You Start

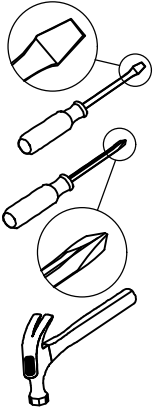

- ✓ Read through each step carefully and follow the proper order
- ✓ Separate and count all your parts and hardware
- ✓ Give yourself enough room for the assembly process
- ✓ Have the following tools: Flat Head Screwdriver, #2 Phillips Head Screwdriver and Hammer
- ✓ Caution: If using a power drill or power screwdriver for screwing, please be aware to slow down and stop when screw is tight. Failure to do so may result in stripping the screw.

Cam Lock Fastening System

This Cam Lock Fastening System will be used throughout the assembly process.

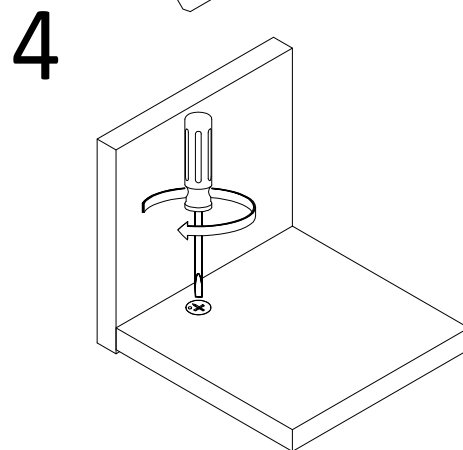
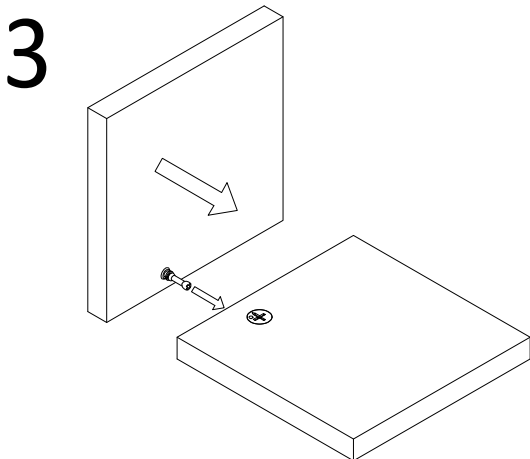
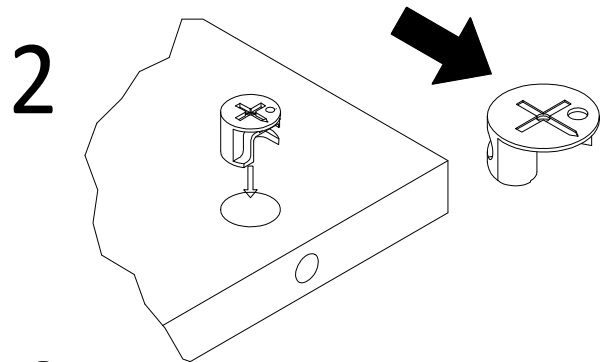
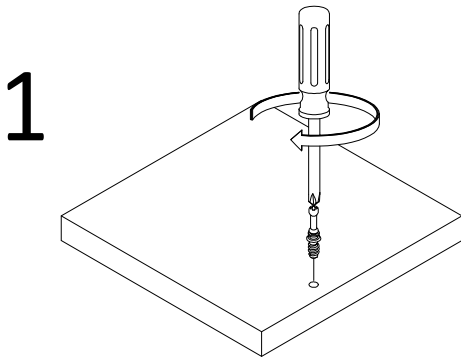

Board Identification

Not Actual Size

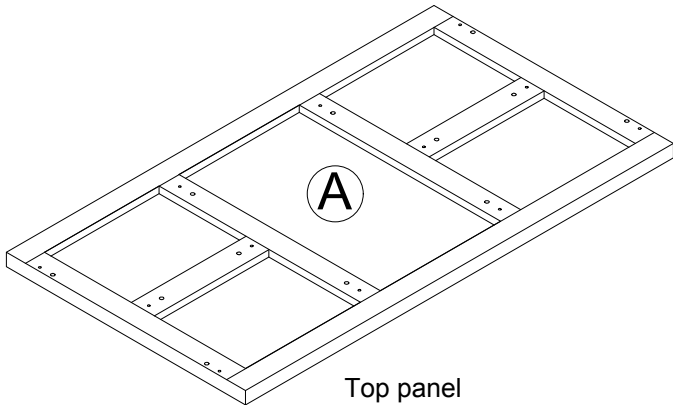

Top panel
T9323013010SF

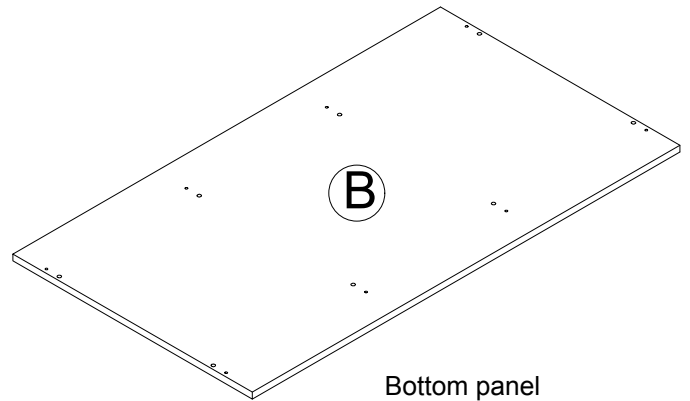

Bottom panel
T9323013020SF

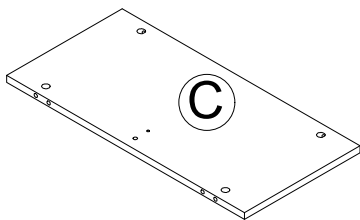

Side panel
T9323013030SF
QTY: 2PCS

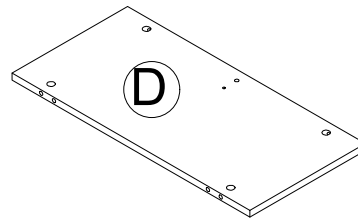

Partition
T9323013040SF
QTY: 2PCS

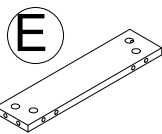

Support panel
T9323013050SF
QTY: 2 PCS

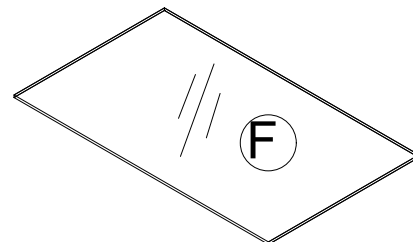

Glass shelf
T9323013060SF

Board Identification

Not Actual Size

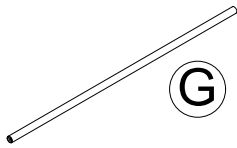

Support tube
T9323013070SF
QTY: 2 PCS

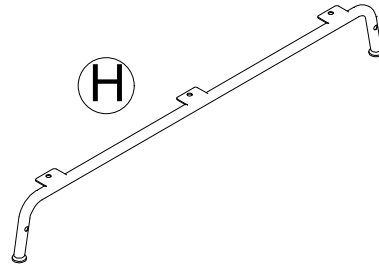

Leg
T9323013080SF
QTY: 2 PCS

Board Identification

Not Actual Size

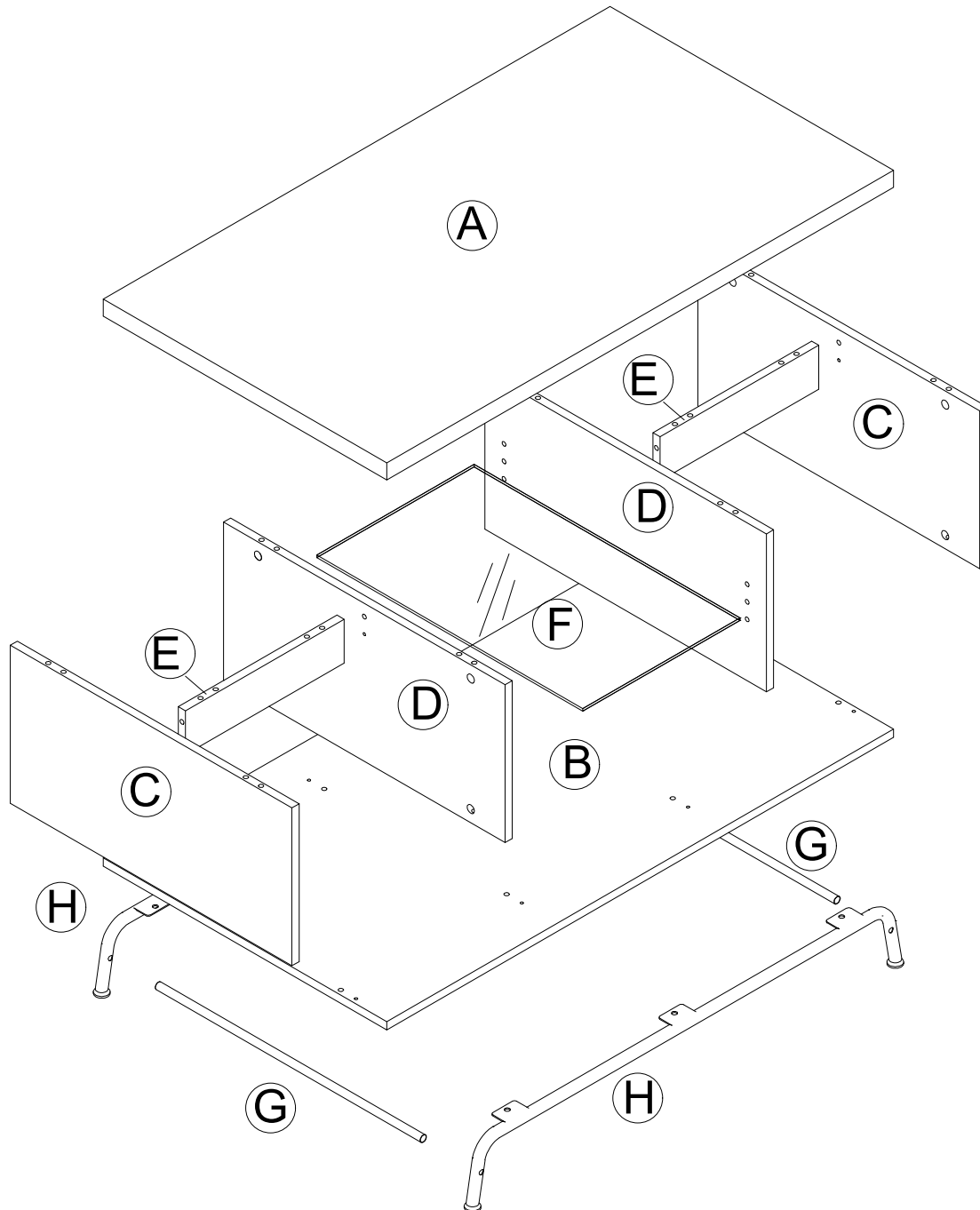

Part List

Actual Size

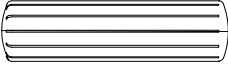

Ø8X30mm

①	x 24
---	------

Wood dowel
TSF0501

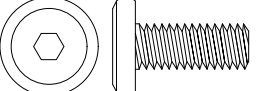

Ø1/4X15mm

②	x 6
---	-----

Bolt
TSF1404

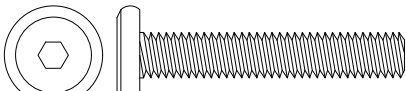

Ø1/4X35mm

③	x 4
---	-----

Bolt
TSF1402

Not Actual Size



HD-02

④	x 24
---	------

Cam cover
TSF3511

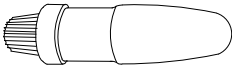

⑤	x 1
---	-----

Glue
TSF0015

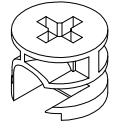

⑥	x 24
---	------

Cam lock
TSF0308



⑦	x 24
---	------

Cam bolt
TSF0355

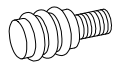

⑧	x 4
---	-----

Shelf support
TSF0552



Ø7 X10XT1.5mm

⑨	x 10
---	------

Spring washer
TSF2451



Ø7X13XT1.5mm

⑩	x 10
---	------

Washer
TSF2453



M4X54mm

⑪	x 1
---	-----

Hex key
TSF2801

STEP 1

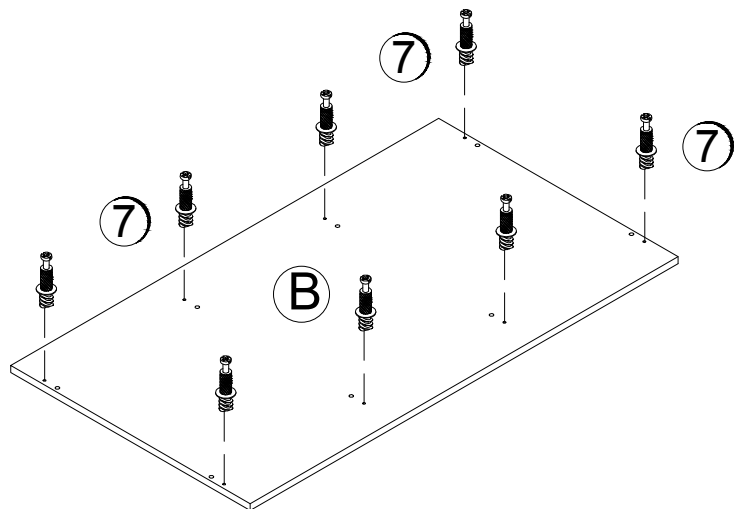
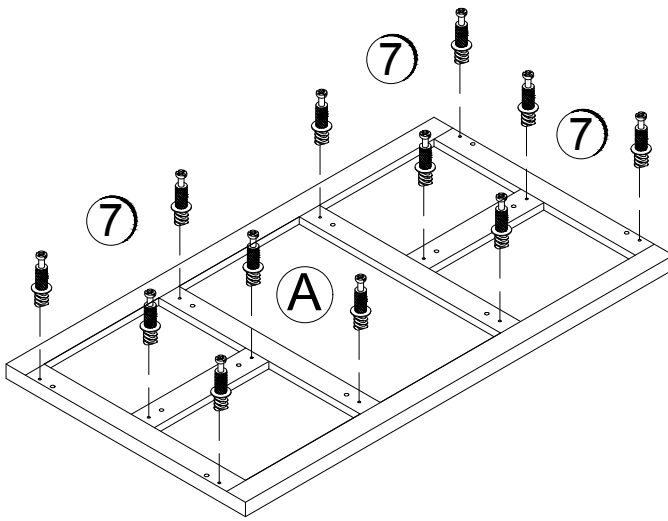
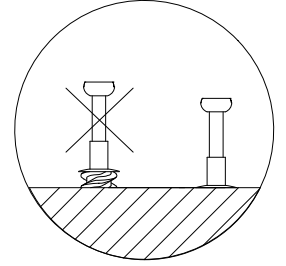
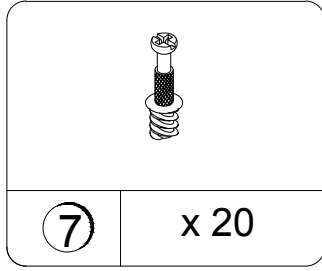
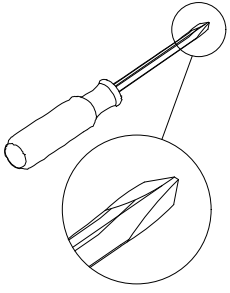



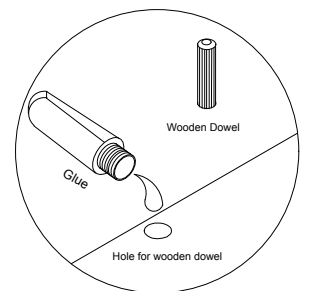
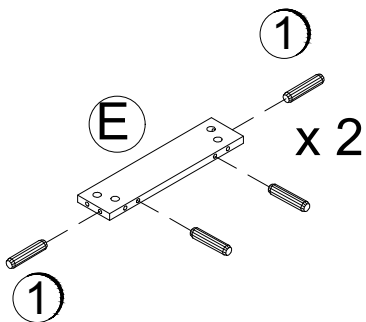
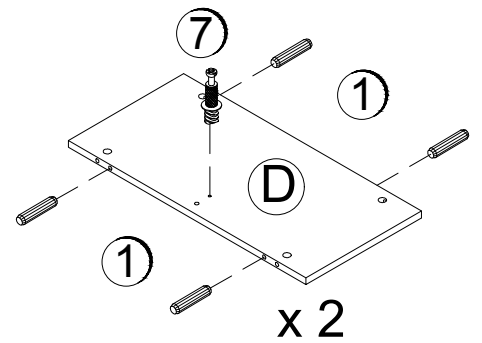
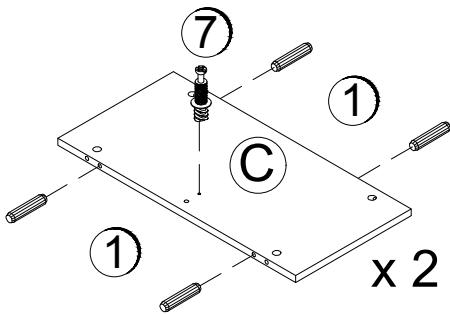
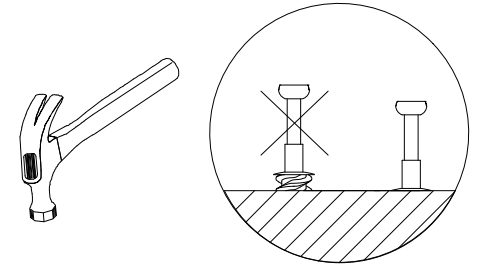
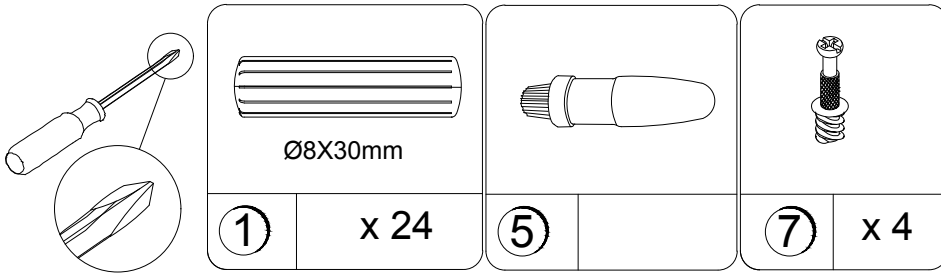

STEP 2

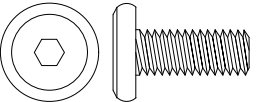
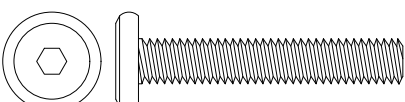

Use one drop of glue in dowel hole.

STEP 3

				
Ø1/4X15mm	Ø1/4X35mm	Ø7 X10XT1.5mm	Ø7X13XT1.5mm	M4X54mm
②	③	⑨	⑩	⑪
x 6	x 4	x 10	x 10	

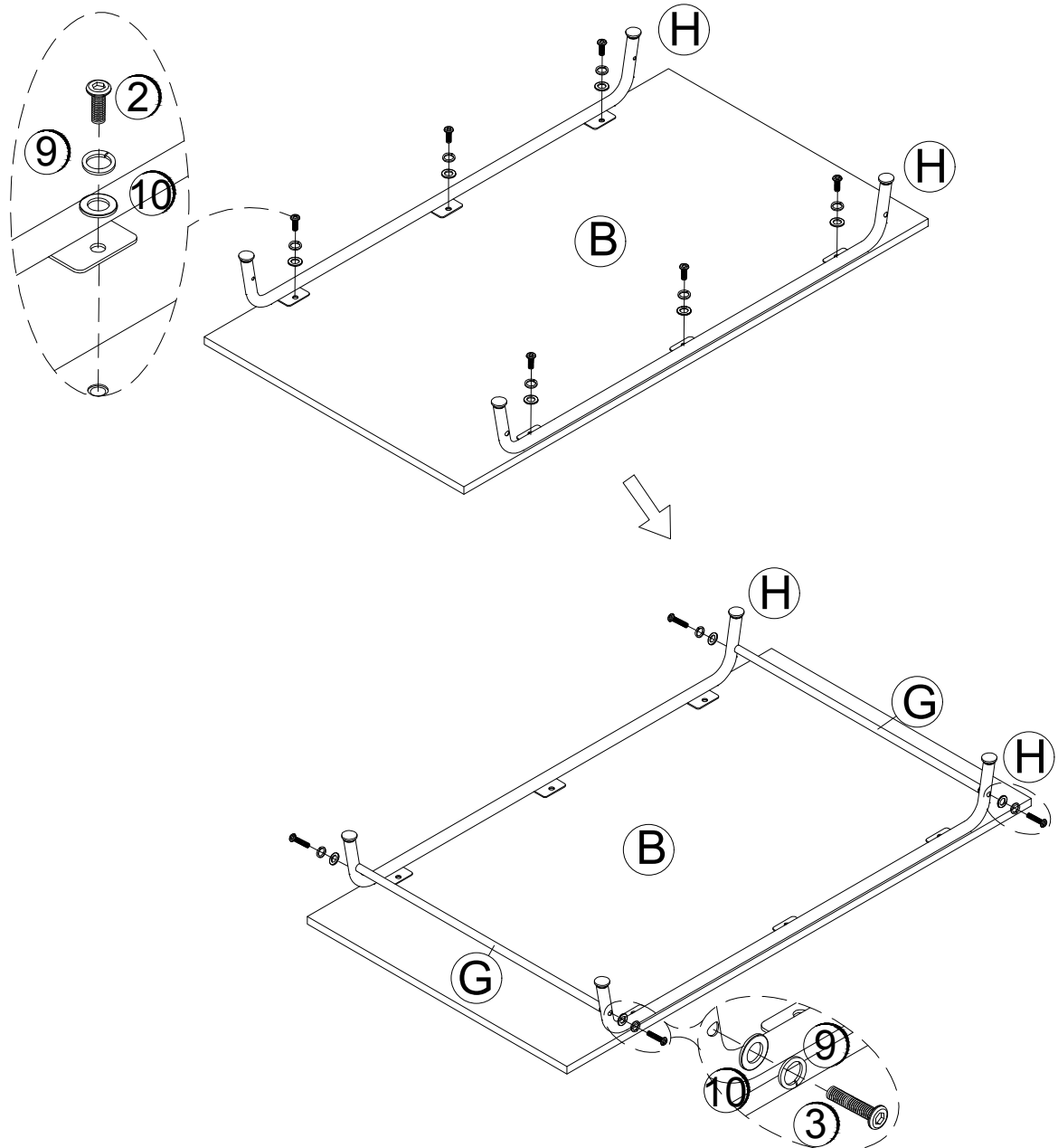

Note: Tighten all bolts to secure the unit in this assembly step.

STEP 4

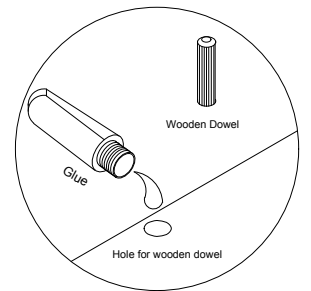
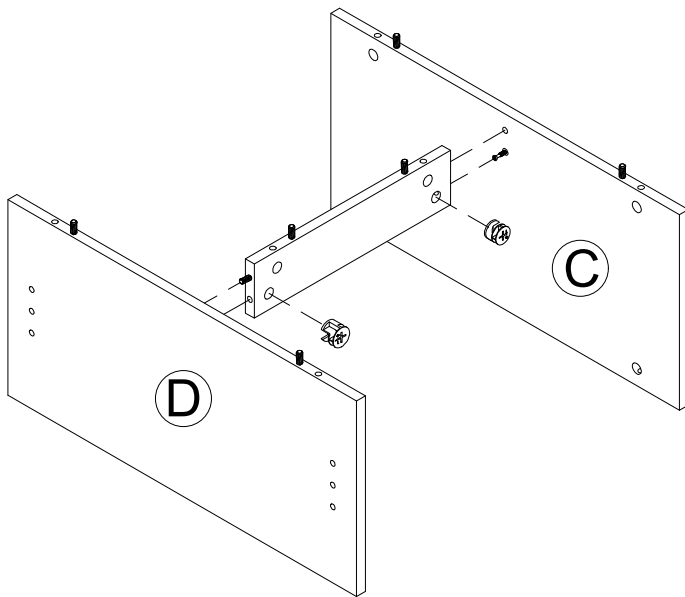
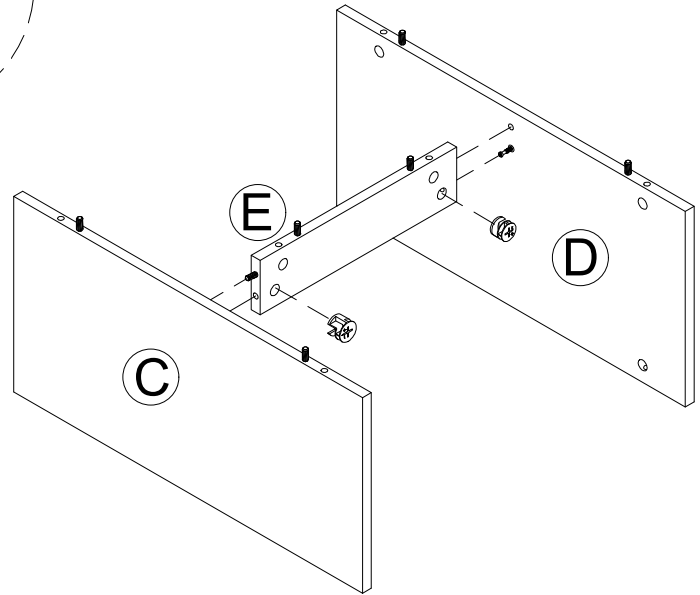
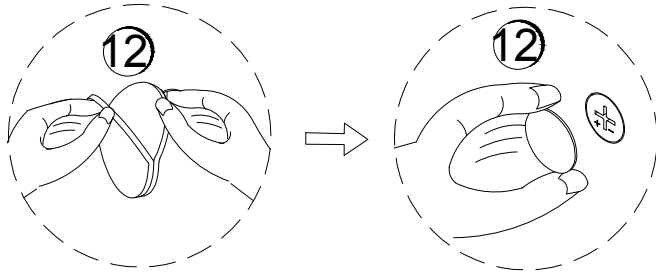
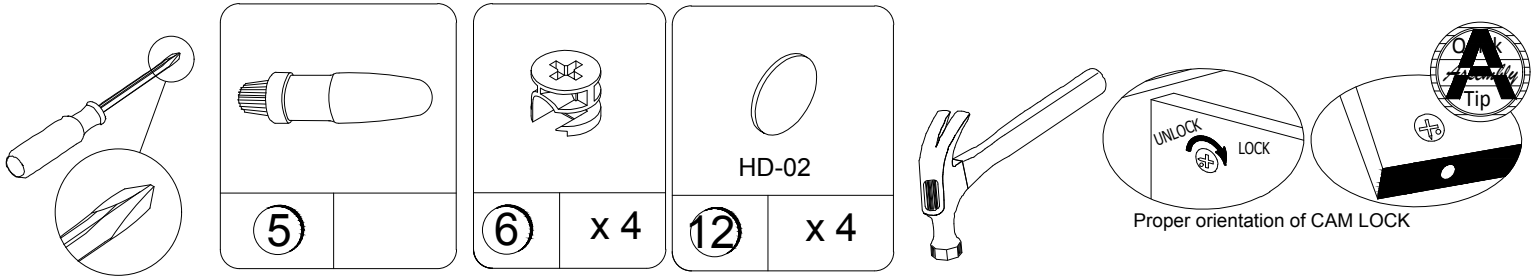

STEP 5

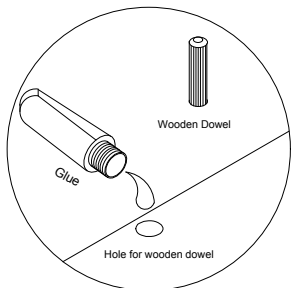
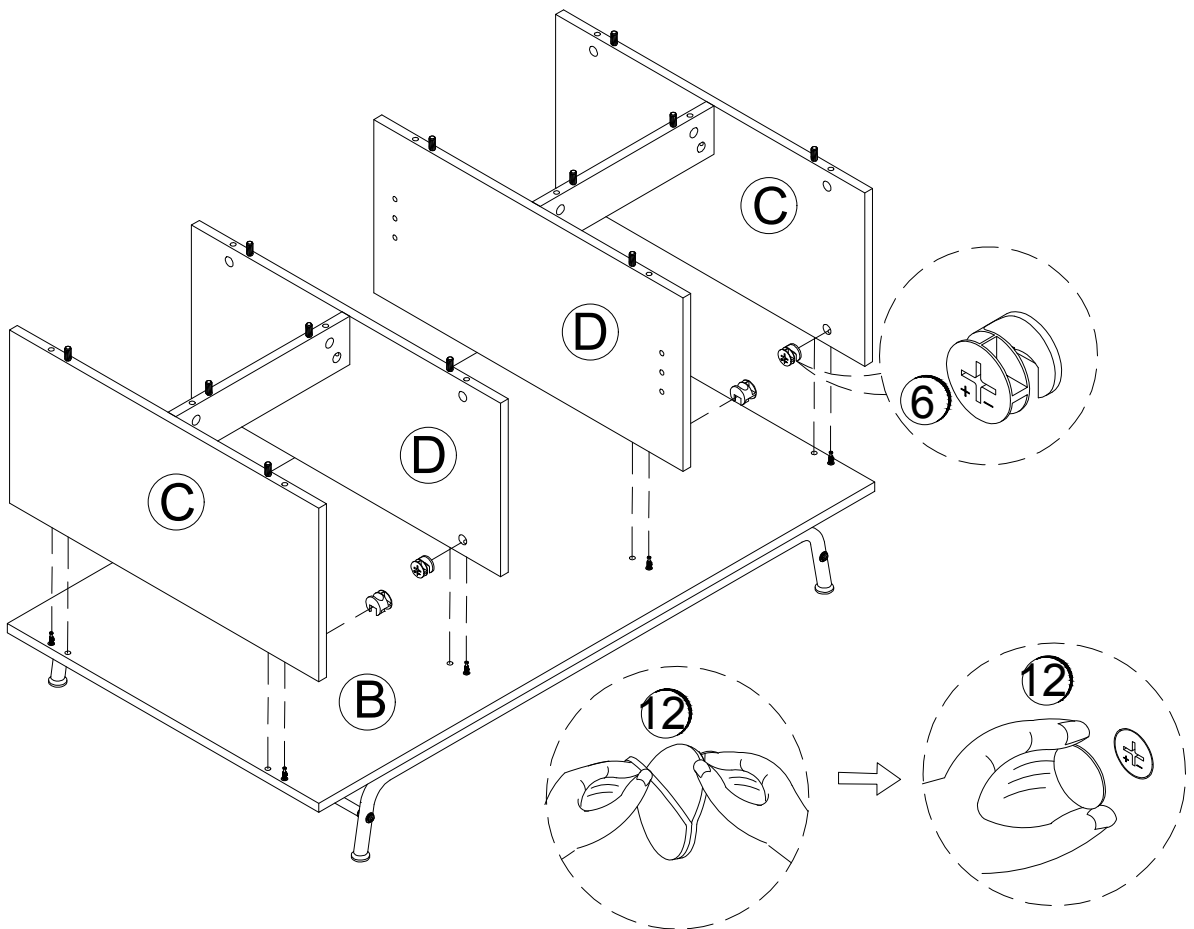
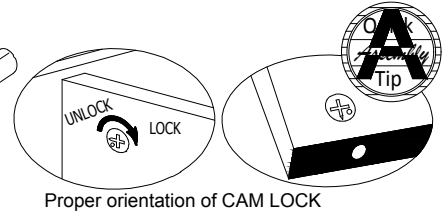
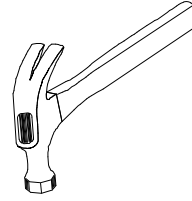
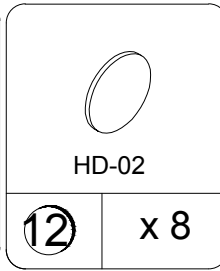
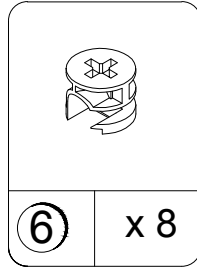
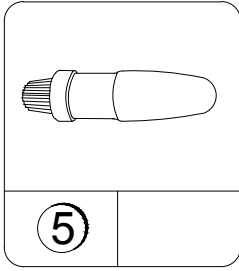
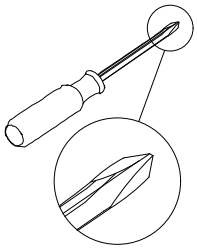

Use one drop of glue in dowel hole.

STEP 6

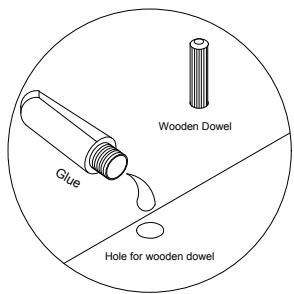
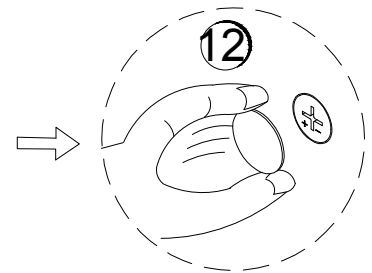
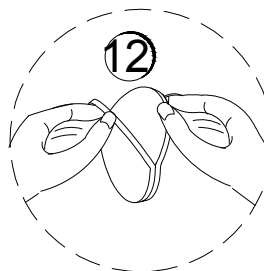
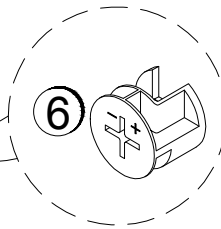
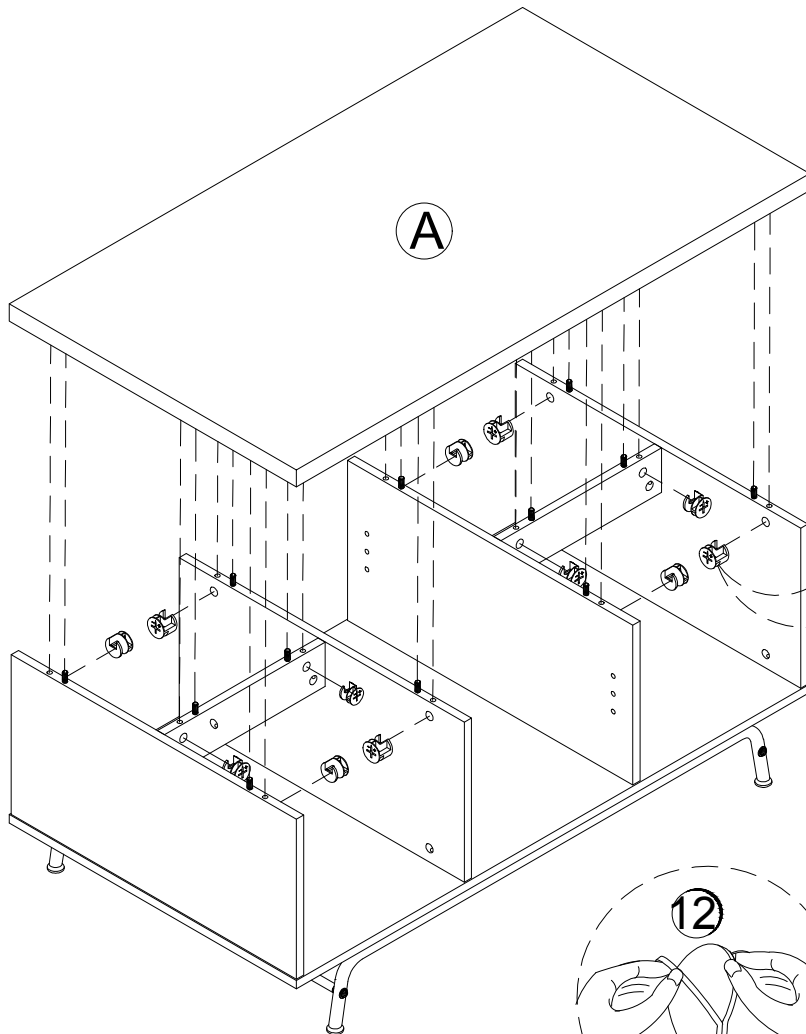
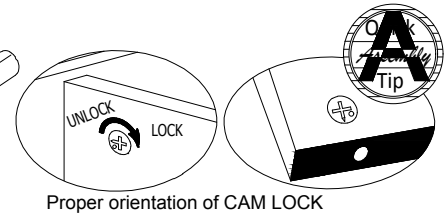
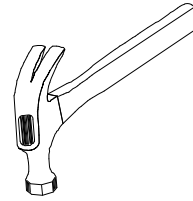
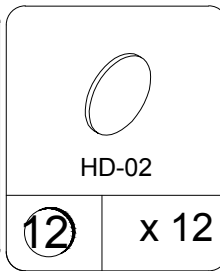
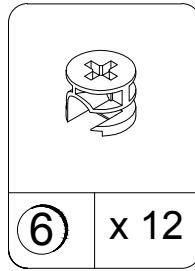
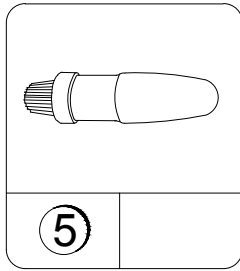
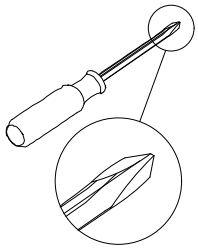

Use one drop of glue in dowel hole.

STEP 7

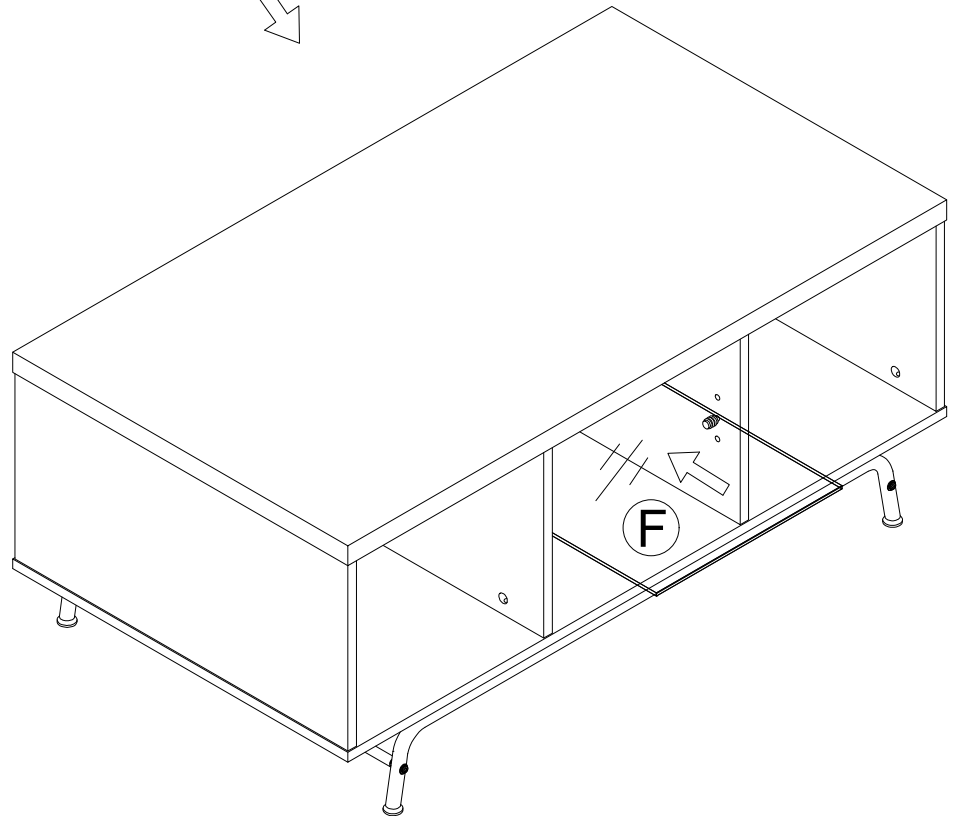
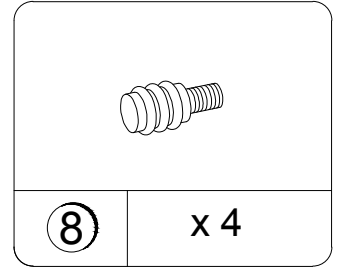
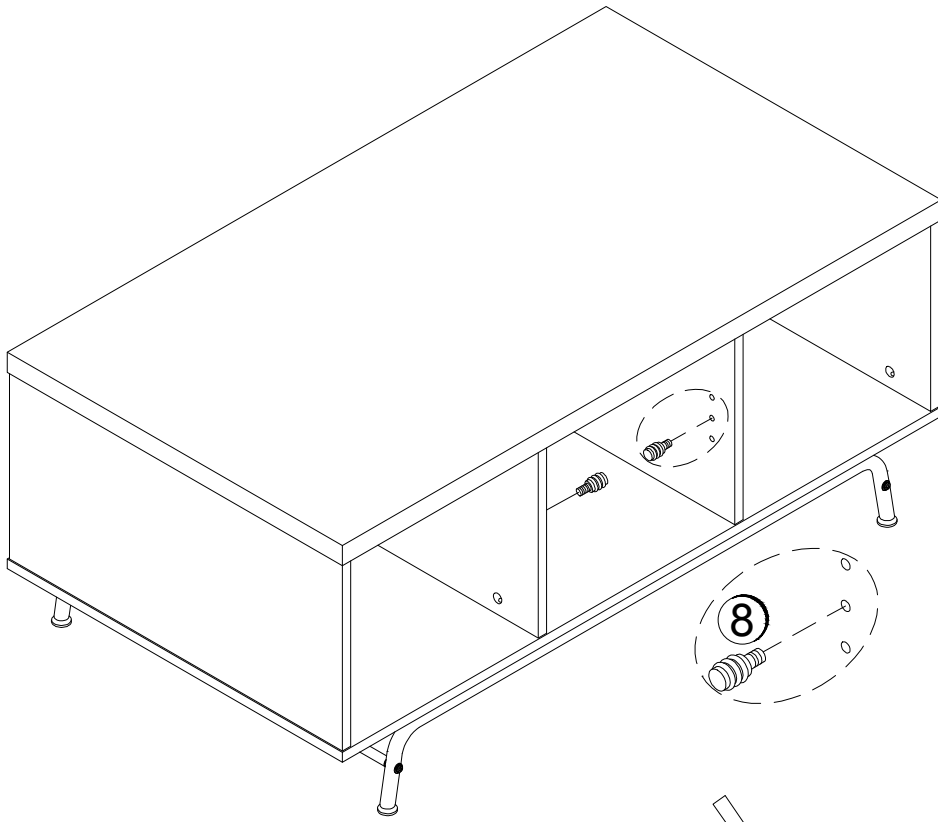

Maximum Loads

This unit has been designed to support the maximum loads shown. Exceeding these load limits could cause sagging, instability, product collapse, and/or serious injury.

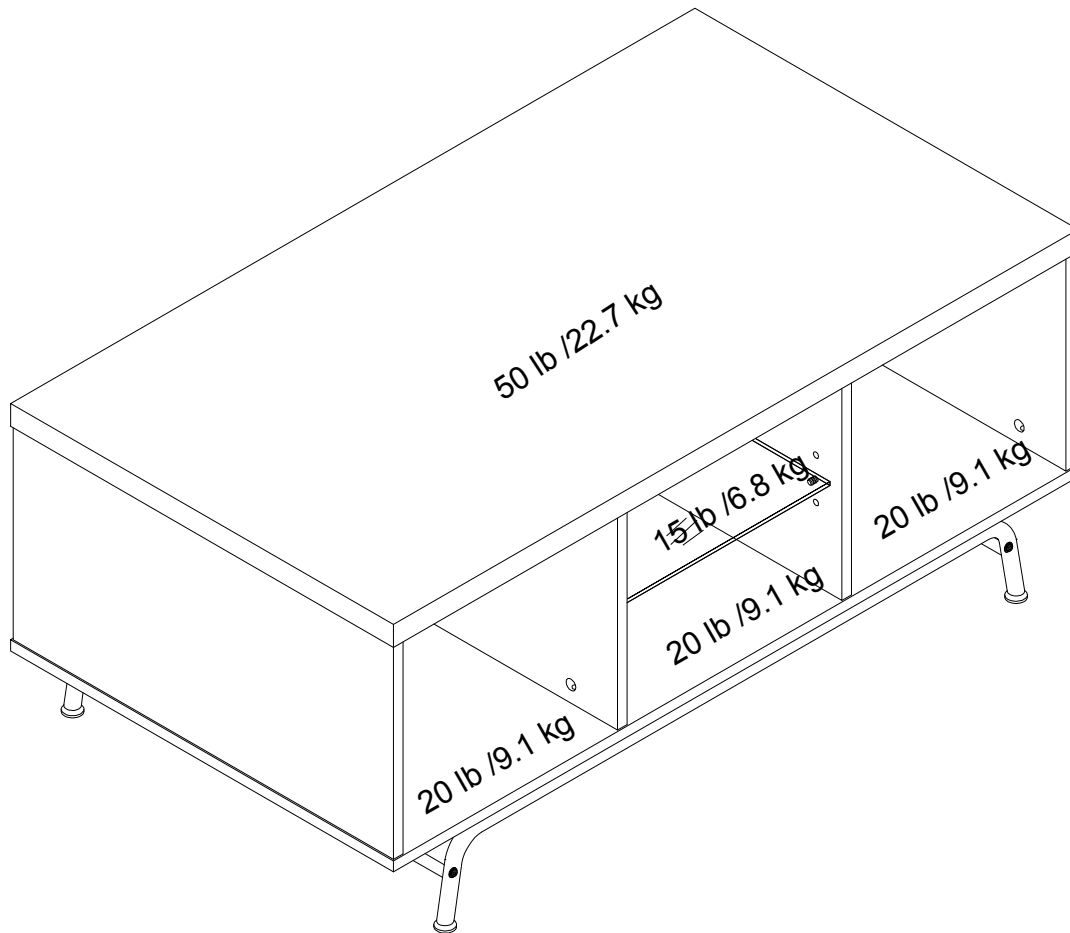

Warning: Risk of injury to persons - do not place a television on this furniture. This furniture is not approved for use with a television.

Certificate of Conformity

1. This certificate applies to the Dorel Home Furnishings, Inc. product identified by this instruction manual.
2. This certificate applies to compliance of this product with the CPSC Ban on Lead-Containing Paint (16 CFR 1303).
3. This product is distributed by: Dorel Home Furnishings, Inc.
410 East First Street South
Wright City, MO 63390
636-745-3351
4. Site of Manufacture: Guangdong China
5. See front page of instruction manual for date of manufacture.

Register your product to receive the following:



- * New trend details - sneak peek on what's new
- * Surveys - have a voice within our community
- * Exclusive deals and discount codes
- * Quick and easy replacement part service

To register your product, visit ameriwoodhome.com

5 Star Rating



Visit your local retailer's website, rate your purchased product and leave us some feedback!

We would like to extend a big "Thank You" to all of our customers for taking the time to assemble this Ameriwood Home product, and to give us your valuable feedback.

*Thank
You*

Cubierta Delantera

Este libro de instrucciones contiene información **IMPORTANTE** de seguridad. Por favor lea y manténgalo para referencia en el futuro.

No Regrese este producto! Comuníquese con nuestro amigoso equipo de servicio al cliente para obtener ayuda. Llámenos al: 1-800-489-3351 (Gratis) Lunes - Viernes 9am - 5pm CST

Visitar: www.ameriwoodhome.com

PRECAUCION

Este mueble puede volcarse y causar graves heridas y/o muerte.

Anclar el mueble a un poste de madera en la pared (si esto se requiere).

No Permita que los niños monten el mueble.

Mantenga los artículos más pesados en los cajones de abajo.

Consejos Útiles (página 2)

- Abra su artículo en el área donde usted planea utilizarlo para evitar levantar y moverlo menos
- Identificar, ordenar y contar las piezas antes de intentar ensamblar
- Las clavijas de compresión se golpean con un martillo
- Las diapositivas están marcadas con una R (derecha) y L (izquierda) para la colocación correcta
- Asegúrese de que siempre este el punto localizado en la parte superior de bloqueador de leva este volteado hacia borde exterior
- Utilizar todos los clavos para el panel de atrás y distribuirlos por igual
- El panel de atrás debe utilizarse para asegurarse de que la unidad quede fija y firme
- No use químicas fuertes ni limpiadores abrasivos en este artículo
- Nunca empuje, tire ni arrastre los muebles

Antes de Que Empieces (página 3)

-Lea cuidadosamente cada paso y siga el orden correcto

-Separar y contar todas sus piezas y hardware

-Dése suficiente espacio para el proceso de ensamble

-Tenga las siguientes herramientas: destornillador de cabeza plana, #2 cabeza Phillips

Destornillador y martillo

-Precaución: Si usa un taladro electrónico o un destornillador eléctrico para atornillar, por favor asegúrese que deje de atornillar cuando el tornillo este apretado. Fallar hacer esto puede causar barrer el tornillo.

Sistema de fijar el bloqueo de leva (página 3)

Esta sistema de fijar el bloqueo de leva sera usado en todo el proceso ensamble.

Identificación de los Paneles (Página 4, 5)

Este no es el tamaño real

- (A) Panel superior
- (B) Panel base
- (C) Panel lateral
- (D) Partición
- (E) Panel de soporte
- (F) Estante de vidrio
- (G) Tube soporte
- (H) Pata

Lista de Piezas (Página 7)

Tamaño real

- (1) Clavija de madera
- (2) Tornillo
- (3) Tornillo

Este no es el tamaño real

- (4) Tapa de la leva
- (5) Pegamento
- (6) Tornillo de cerradura
- (7) Tornillo de rosca
- (8) Soporte de repisa
- (9) Arandela de resorte
- (10) Arandela
- (11) Llave en I

Página 9

Agujero para clavija de madera. Use una gota de pegamento en el agujero de clavija.

Página 10

Nota: Apriete todos los pernos para estabilizar la unidad en este paso.

Página 11, 12, 13

Agujero para clavija de madera. Use una gota de pegamento en el agujero de clavija.

Página 15

CARGA MAXIMA

Esta unidad ha sido diseñada para soportar la carga máxima anotada. El exceder estos límites puede causar inestabilidad, colapsarse y/o causar serias lesiones.

ADVERTENCIA: Riesgo de lesiones a las personas - no coloque un televisor sobre muebles. Este mueble no está aprobado para su uso con un televisor.

Página 16

Registre su producto para recibir lo siguiente:

- * Detalles de nuevas tendencias - Vistazo a lo nuevo
- * Encuestas - alee su voz entre su comunidad
- * Códigos de ofertas y descuentos exclusivos
- * Fácil y rápido servicio de partes de remplace

Para registrar su producto, visite ameriwoodhome.com

Clasificación de 5 estrellas

Visite el sitio web de su tienda local, califique su comprado y denos sus comentarios!

Nos gustaría enviar un gran "Agradecimiento" a todos nuestros clientes por tomarse el tiempo de ensamblar este producto de Ameriwood Home, y por darnos sus valiosos comentarios.

Gracias

Couverture Avant

CE LIVRET D'INSTRUCTION CONTIENT DES INFORMATIONS **IMPORTANTES** SUR LA SÉCURITÉ. VEUILLEZ LIRE ET GARDER POUR UNE RÉFÉRENCE FUTURE

Ne retournez pas ce produit! Contactez notre équipe de service à la clientèle amicale d'abord pour obtenir de l'aide.

Appelez-nous: 1-800-489-3351 (sans frais) du Lundi au Vendredi de 9h à 17h Heure Centrale

Visitez: www.ameriwoodhome.com

ATTENTION

Le meuble peut basculer et causer des blessures graves ou la mort.

Ancrer le meuble à une planche murale dans le mur (si indiqué).

Ne laissez pas les enfants grimper sur le meuble.

Placez les articles lourds sur les étagères ou dans les tiroirs inférieurs.

Astuces Utiles (page 2)

-Ouvrez votre article dans la zone que vous prévoyez de le garder pour moins de levage lourd

-Identifier, trier et compter les pièces avant d'essayer d'assembler

-Les goujons de compression sont taraudés avec un Marteau

-Les glissières sont marquées d'un R (droit) et d'un L (gauche) pour un bon placement

-Assurez-vous toujours de faire face la pointe situé sur le haut de la Serrure de Came vers le bord extérieur

-Utiliser tous les clous fournis pour le panneau arrière et les répartir également

-Le panneau arrière doit être utilisé pour vous assurer que votre appareil est robuste

-N'utilisez pas de produits chimiques agressifs ou de nettoyants abrasifs sur cet appareil

-Ne jamais pousser, tirer, ou faire glisser votre meuble

Avant de Commencer (page 3)

-Lisez attentivement chaque étape et suivez le bon ordre

-Séparez et comptez toutes vos pièces et matériaux

-Donnez-vous suffisamment de place pour l'assemblage

-Avoir les outils suivants: tournevis à tête plate, #2 tournevis Phillips, et Marteau

-Attention: Si vous utilisez une perceuse électrique ou un tournevis électrique pour visser, veuillez à ralentir et arrêter lorsque la vis est bien serrée. Le non-respect de cette consigne peut endommager la vis.

Système de Fixation de Came (page 3)

Ce Système de Fixation de Came sera utilisé tout au long de l'assemblage

Identification des matériaux (Étape 4,5)

Pas de taille réelle

- (A) Panneau supérieur
- (B) Panneau inférieur
- (C) Panneau latéral
- (D) Cloison
- (E) Panneau de support
- (F) Étagère en verre
- (G) Tube de soutien
- (H) Patte

Liste des pièces (Étape 7)

Taille réelle

- (1) Goujon en bois
- (2) Boulon
- (3) Boulon

Pas de taille réelle

- (4) Abri de la came
- (5) Colle
- (6) Serrure de came
- (7) Boulon de camde
- (8) Support de tablette
- (9) Rondelle à ressort
- (10) Rondelle
- (11) Clé hexagonale

Étape 9

Trou pour cheville en bois. Utilisez une goutte de colle dans le trou de la cheville.

Étape 10

Note: Serrez tous les boulons à cette étape pour bien fixer l'unité.

Étape 11, 12, 13

Trou pour cheville en bois. Utilisez une goutte de colle dans le trou de la cheville.

Étape 15

CHARGES MAXIMALES

Ce meuble a été conçu pour supporter les charges maximales indiquées. En excédant ces limites de charge, le meuble pourrait devenir instable, s'effondrer, et/ou causer des blessures graves.

AVERTISSEMENT : Risque de blessure corporelle - ne pas placer une télévision sur ce meuble. Ce meuble n'est pas approuvé pour une utilisation avec une télévision.

Étape 16

Enregistrez votre produit pour recevoir les éléments suivantes:

- * Détails sur les nouvelles tendances - un aperçu sur les nouveautés
- * Sondages - avoir une voix au sein de notre communauté
- * Offres exclusives et codes promo
- * Service de pièces de rechange rapide et facile

Pour enregistrer votre produit, visitez ameriwoodhome.com

5 Étoiles

Visitez le site Web de votre détaillant local, évaluez votre produit acheté et laissez-nous quelques commentaires !

Nous tenons à offrir un grand "Merci" à tous nos clients pour avoir pris le temps d'assembler ce produit "Ameriwood Home", et de nous donner vos commentaires précieux.

Merci