

- 1635015COM
- 1635214COM 1635326COM
- 1635301COM 1635327COM
- 1635318COM 1635342COM

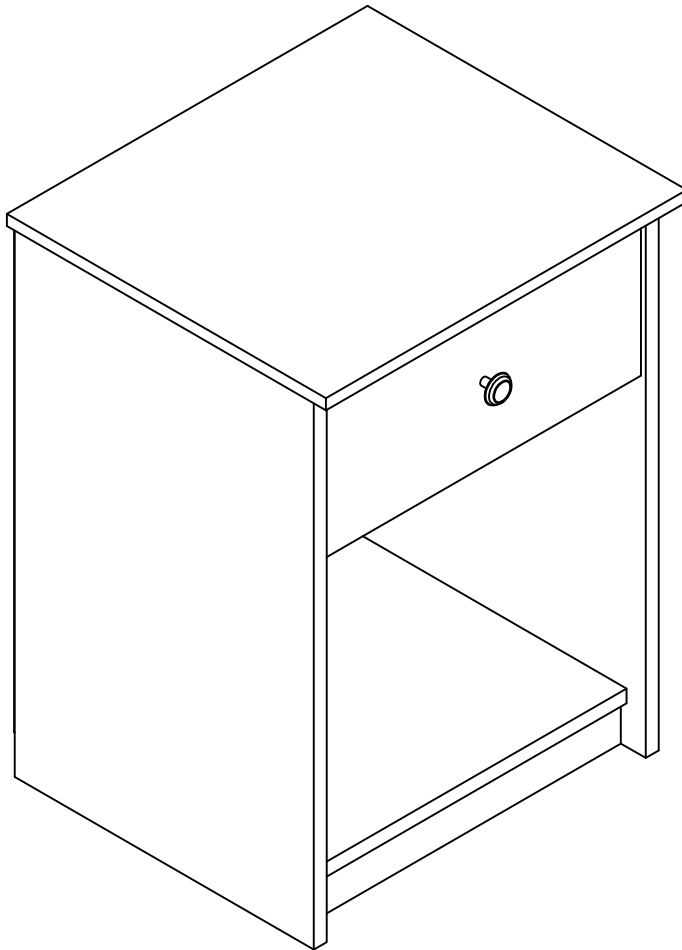

Date of Purchase ___ / ___ / ___
 Lot Number:

B34163500COM0



THIS INSTRUCTION BOOKLET CONTAINS **IMPORTANT** SAFETY INFORMATION. PLEASE READ AND KEEP FOR FUTURE REFERENCE.

Do Not Return This Product!

Contact our customer service team for help first.

Call: 1-800-489-3351 (toll free)

Monday-Friday 9am - 5pm CST

Visit: www.ameriwoodhome.com



WARNING

- Unit can tip over causing severe injury or death.
- Anchor unit to stud in wall (if instructed to).
- Do Not allow children to climb on unit.
- Put heavy items on lower shelves or drawers.

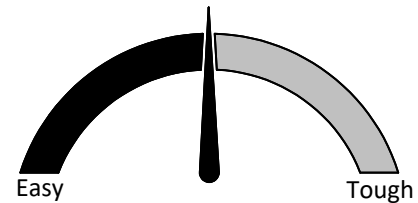

Assembly Difficulty Meter

Follow Ameriwood Home



Contact Us!

Do NOT return this product!

Contact our friendly customer service team first for help.

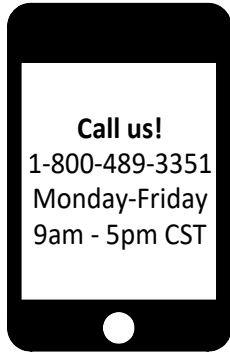

Visit ameriwoodhome.com to view the limited warranty valid in the U.S. and Canada.

Assembly Tips



Helpful Hints

PEOPLE NEEDED FOR ASSEMBLY: 1-2

- Open your item in the area you plan to keep it to avoid excessive heavy lifting.
- Identify, sort and count the parts before attempting assembly.
- Compression dowels are lightly tapped in with a hammer.
- Slides are labeled with a **R** (right) and **L** (left) for proper placement.
- Make sure to always face the point on the top of the Cam Lock towards the outer edge.
- Use all the nails provided for the back panel and spread them out equally.
- Back panel must be used to make sure your unit is sturdy.
- Do NOT use harsh chemicals or abrasive cleaners on this item.
- Never push, pull, or drag your furniture.

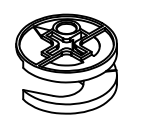
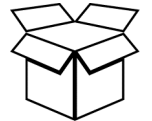

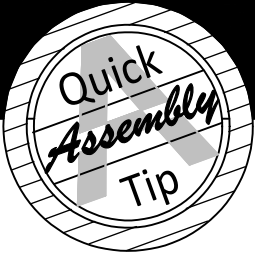

Before You Start

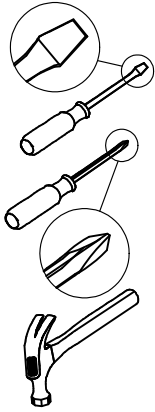

- ✓ Read through each step carefully and follow the proper order
- ✓ Separate and count all your parts and hardware
- ✓ Give yourself enough room for the assembly process
- ✓ Have the following tools: Flat Head Screwdriver, #2 Phillips Head Screwdriver and Hammer
- ✓ Caution: If using a power drill or power screwdriver for screwing, please be aware to slow down and stop when screw is tight. Failure to do so may result in stripping the screw.

Cam Lock Fastening System

This Cam Lock Fastening System will be used throughout the assembly process.

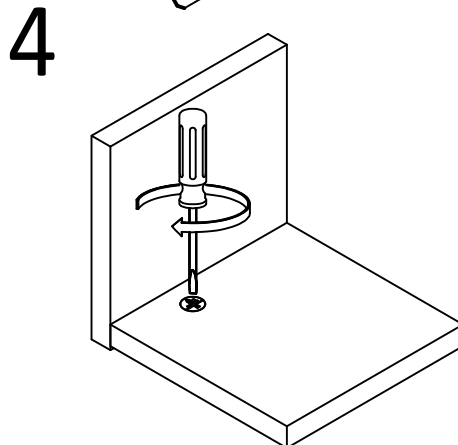
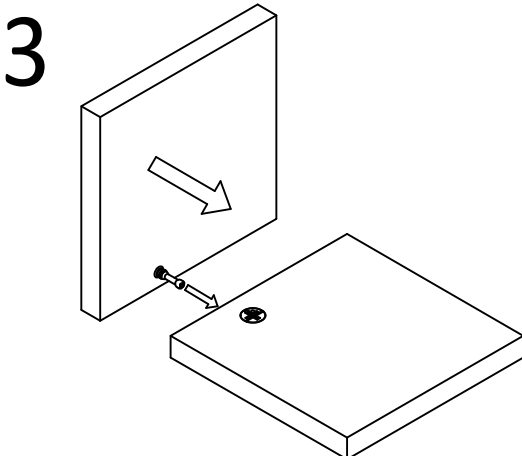
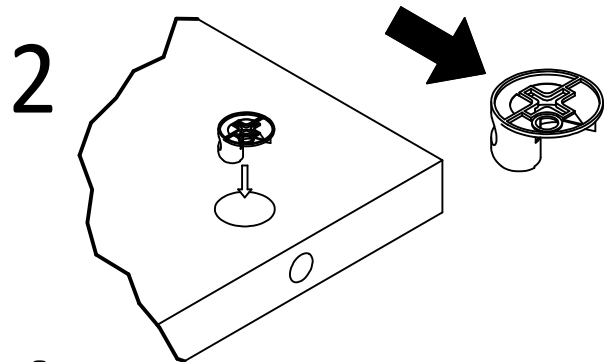
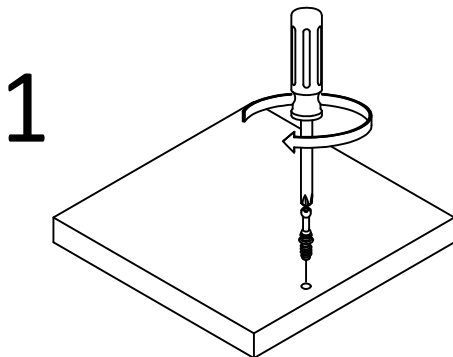

Board Identification

Not actual size

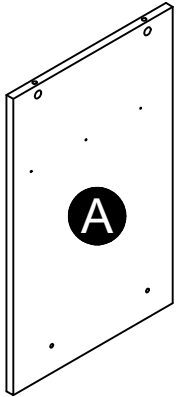

Left Panel
31635015010

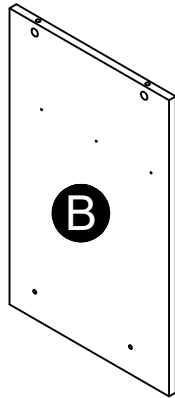

Right Panel
31635015020

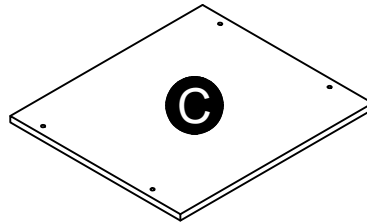

Top
31635015030

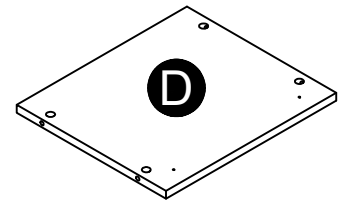

Bottom
31635015040

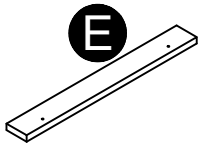

Kick
31635015050

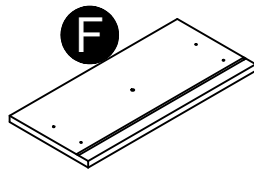

Drawer Front
31635015060

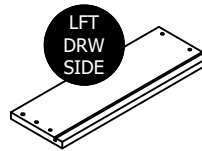

Left Drawer side
39992120346010L

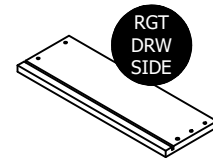

Right Drawer Side
39992120346010R



Drawer Back
39992120034700B

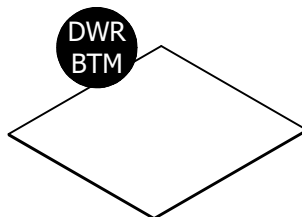

Drawer Bottom
39992340035710D

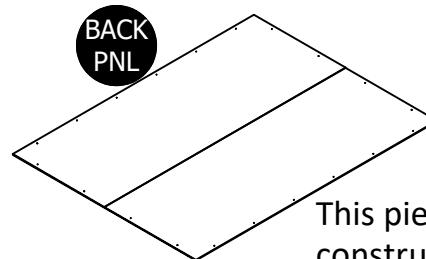

Back Panel
K163501500

This piece is paperboard construction. It is not made from wood, but is required for the assembly of your unit.

Board Identification

Not actual size

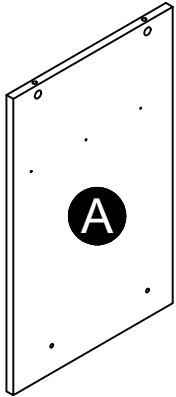

Left Panel
31635214010

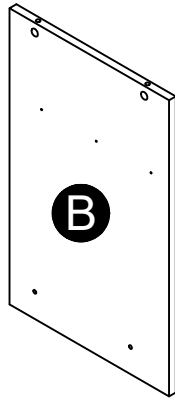

Right Panel
31635214020

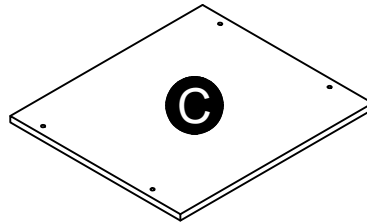

Top
31635214030

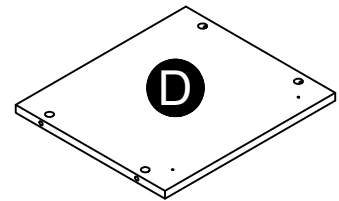

Bottom
31635214040

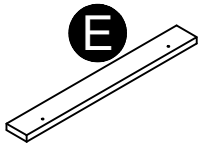

Kick
31635214050

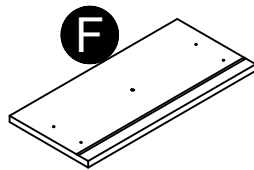

Drawer Front
31635214060

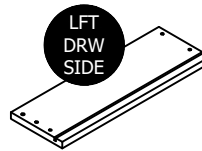

Left Drawer side
39992120346010L

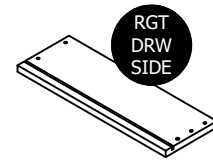

Right Drawer Side
39992120346010R



Drawer Back
39992120034700B

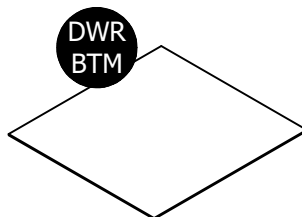

Drawer Bottom
39992340035710D

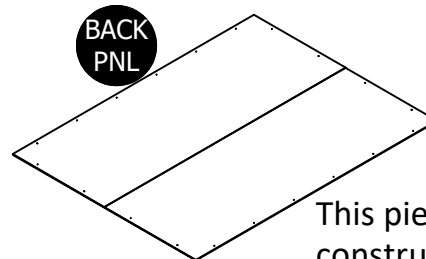

Back Panel
K163521400

This piece is paperboard construction. It is not made from wood, but is required for the assembly of your unit.

Board Identification

Not actual size

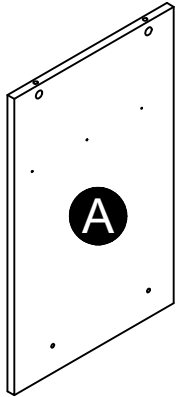

Left Panel
31635301010

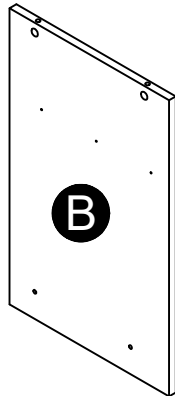

Right Panel
31635301020

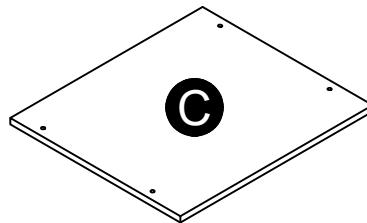

Top
31635301030

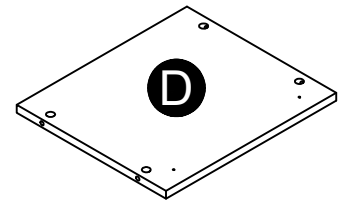

Bottom
31635301040

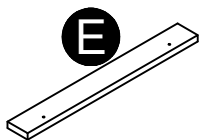

Kick
31635301050

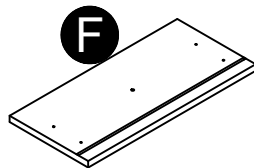

Drawer Front
31635301060

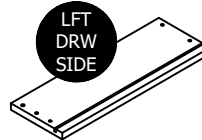

Left Drawer side
39992120346010L

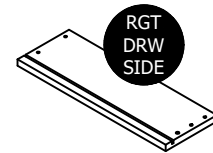

Right Drawer Side
39992120346010R



Drawer Back
39992120034700B

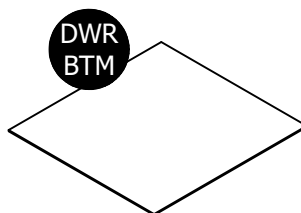

Drawer Bottom
39992340035710D

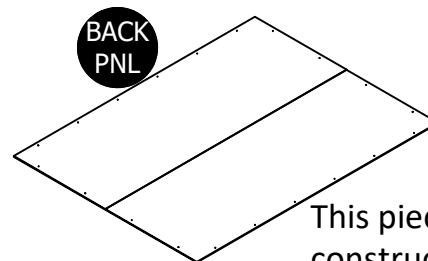

Back Panel
K163530100

This piece is paperboard construction. It is not made from wood, but is required for the assembly of your unit.

Board Identification

Not actual size

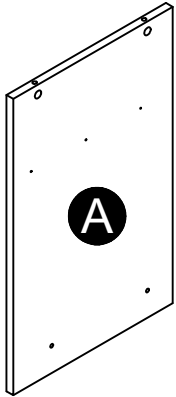

Left Panel
31635318010

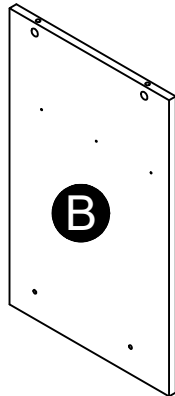

Right Panel
31635318020

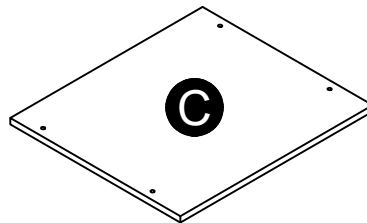

Top
31635318030

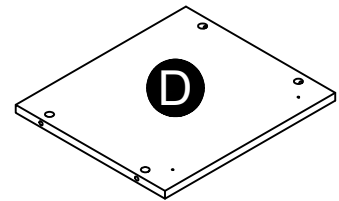

Bottom
31635318040

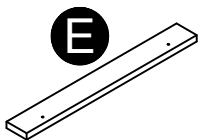

Kick
31635318050

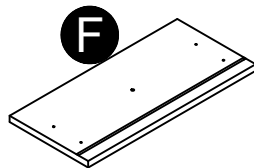

Drawer Front
31635318060

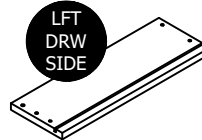

Left Drawer side
39992120346010L

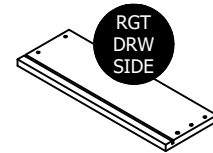

Right Drawer Side
39992120346010R

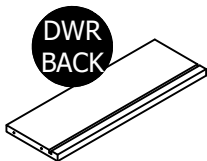

Drawer Back
39992120034700B

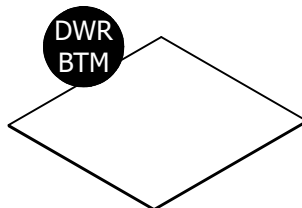

Drawer Bottom
39992340035710D

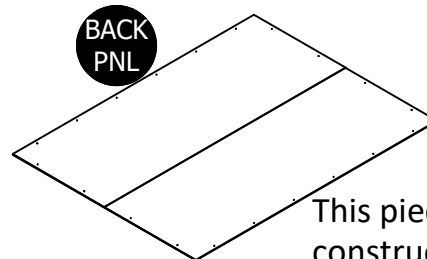

Back Panel
K163531800

This piece is paperboard construction. It is not made from wood, but is required for the assembly of your unit.

Board Identification

Not actual size

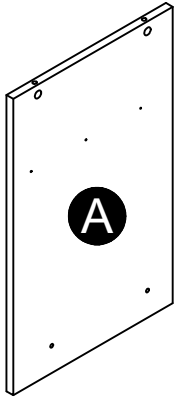

Left Panel
31635326010

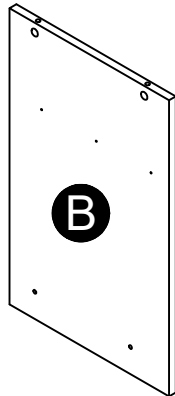

Right Panel
31635326020

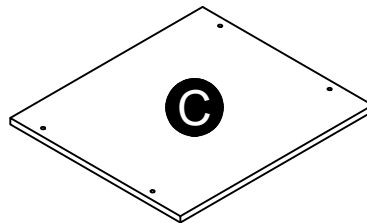

Top
31635326030

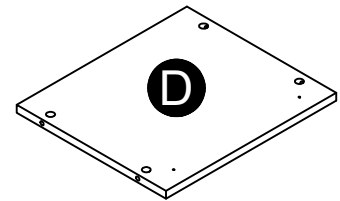

Bottom
31635326040

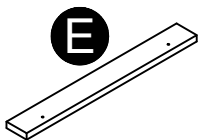

Kick
31635326050

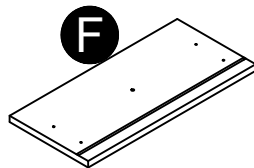

Drawer Front
31635326060

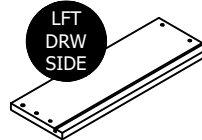

Left Drawer side
39992120346010L

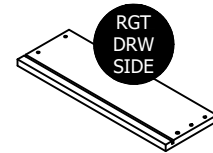

Right Drawer Side
39992120346010R

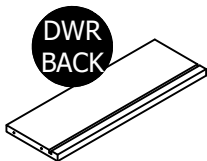

Drawer Back
39992120034700B

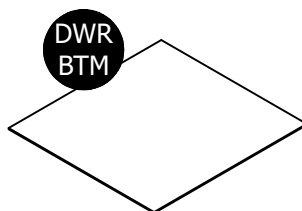

Drawer Bottom
39992340035710D

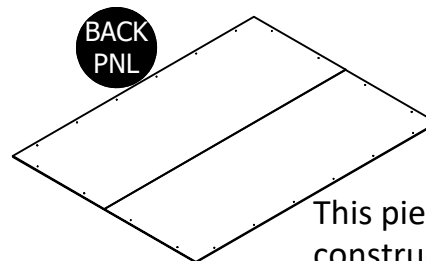

Back Panel
K163532600

This piece is paperboard construction. It is not made from wood, but is required for the assembly of your unit.

Board Identification

Not actual size

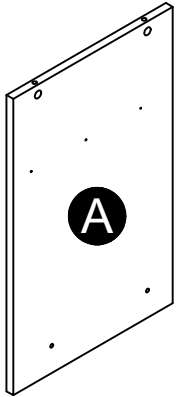

Left Panel
31635327010

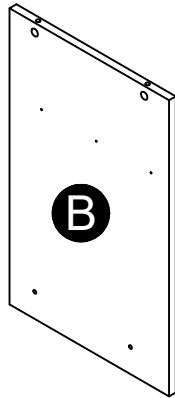

Right Panel
31635327020

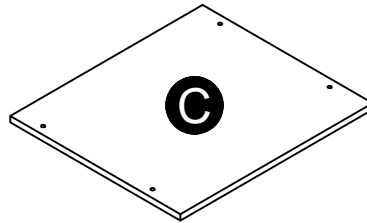

Top
31635327030

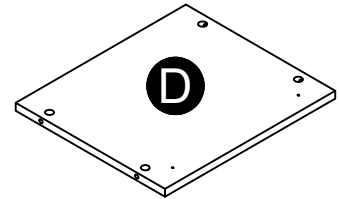

Bottom
31635327040

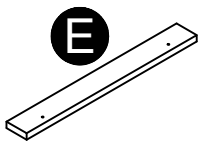

Kick
31635327050

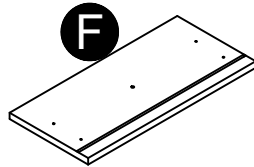

Drawer Front
31635327060

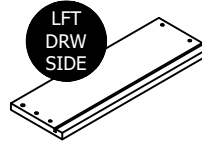

Left Drawer side
39992120346010L

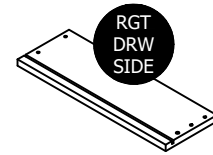

Right Drawer Side
39992120346010R



Drawer Back
39992120034700B

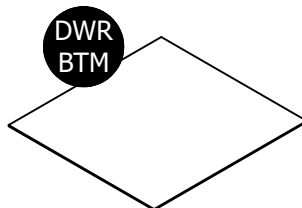

Drawer Bottom
39992340035710D

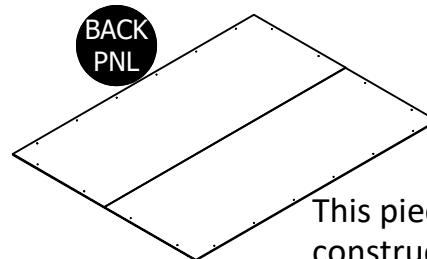

Back Panel
K163532700

This piece is paperboard construction. It is not made from wood, but is required for the assembly of your unit.

Board Identification

Not actual size

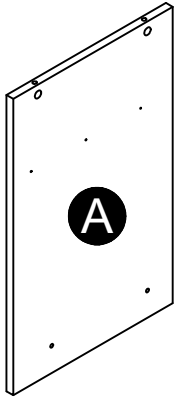

Left Panel
31635342010

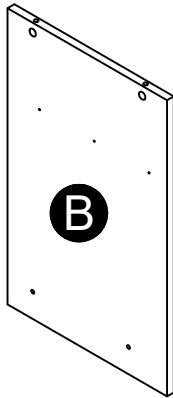

Right Panel
31635342020

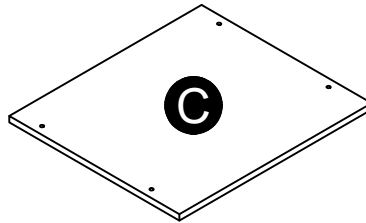

Top
31635342030

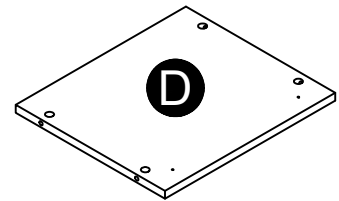

Bottom
31635342040

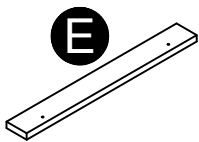

Kick
31635342050

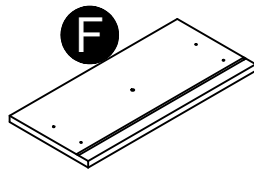

Drawer Front
31635342060

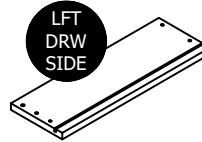

Left Drawer side
39992120346010L

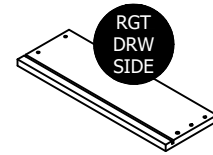

Right Drawer Side
39992120346010R



Drawer Back
39992120034700B

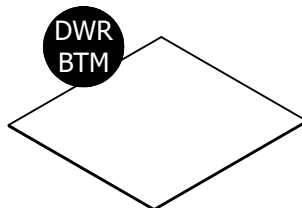

Drawer Bottom
39992340035710D

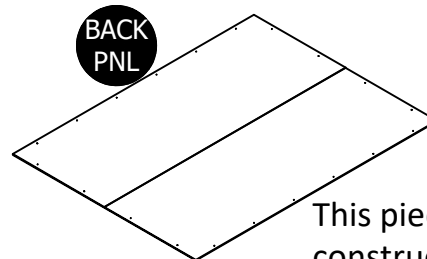

Back Panel
K163534200

This piece is paperboard construction. It is not made from wood, but is required for the assembly of your unit.

Board Identification

Not actual size

This piece is paperboard construction. It is not made from wood, but is required for the assembly of your unit.

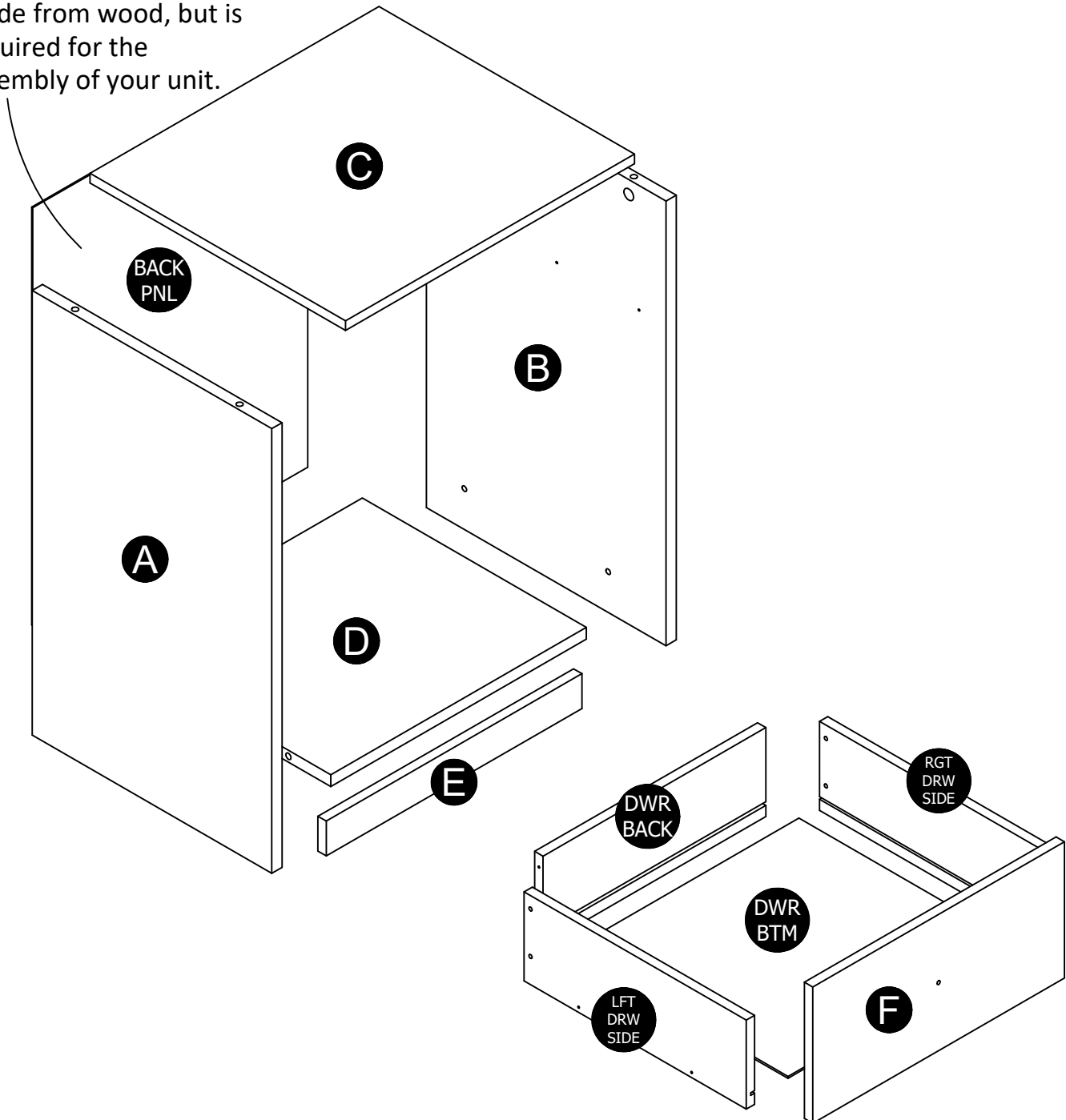

Part List

Actual Size

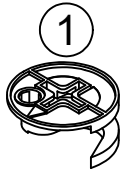

(x8)
#A22620
cam lock

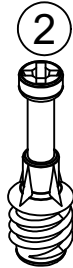

(x8)
#A22610
cam bolt

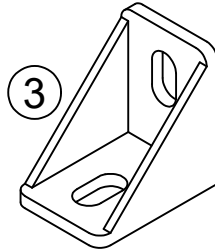

(x2)
#A53510
angle bracket



(x8)
#A12120
7/16" pan



(x10)
#A11080
7/16" flat

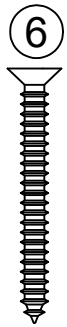

(x4)
#A11600
1-1/4" flat



(x1)
#A12930
1-1/8" pan

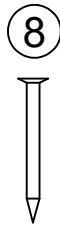

(x20)
#A21110
nail

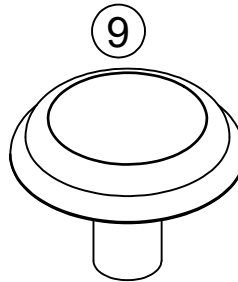

(x1)
#A51965
knob

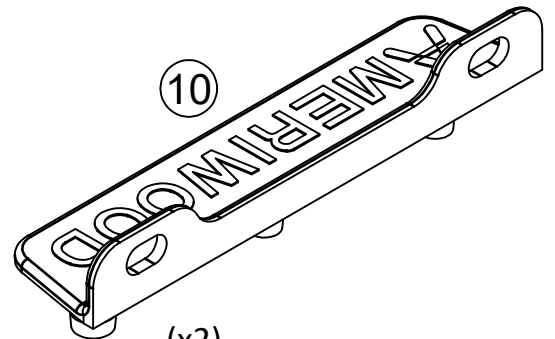

(x2)
#A54213
drawer bracket

Not Actual Size

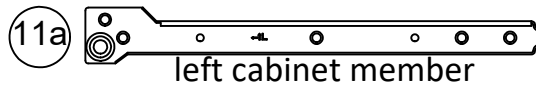

left cabinet member

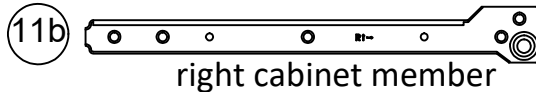

right cabinet member

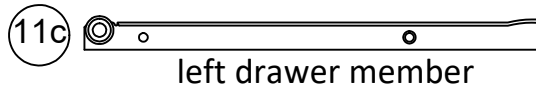

left drawer member

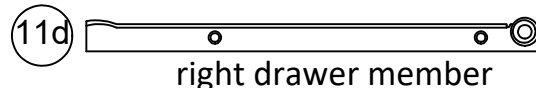

right drawer member

(x1)
#A56720
drawer slide

STEP 1

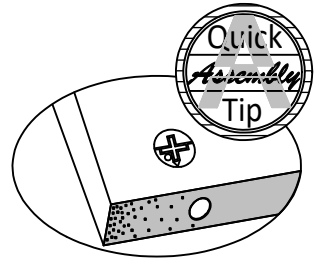
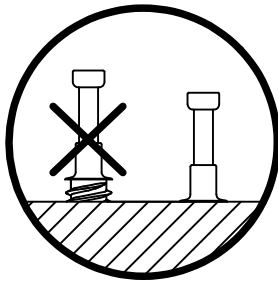
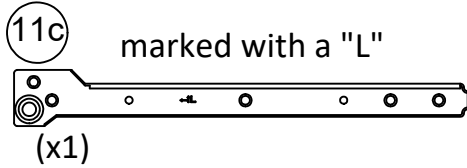
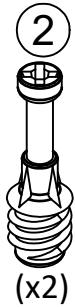
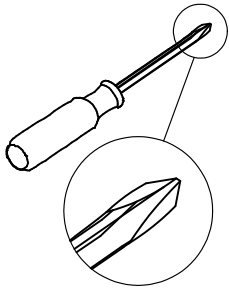

Proper orientation of CAM LOCK

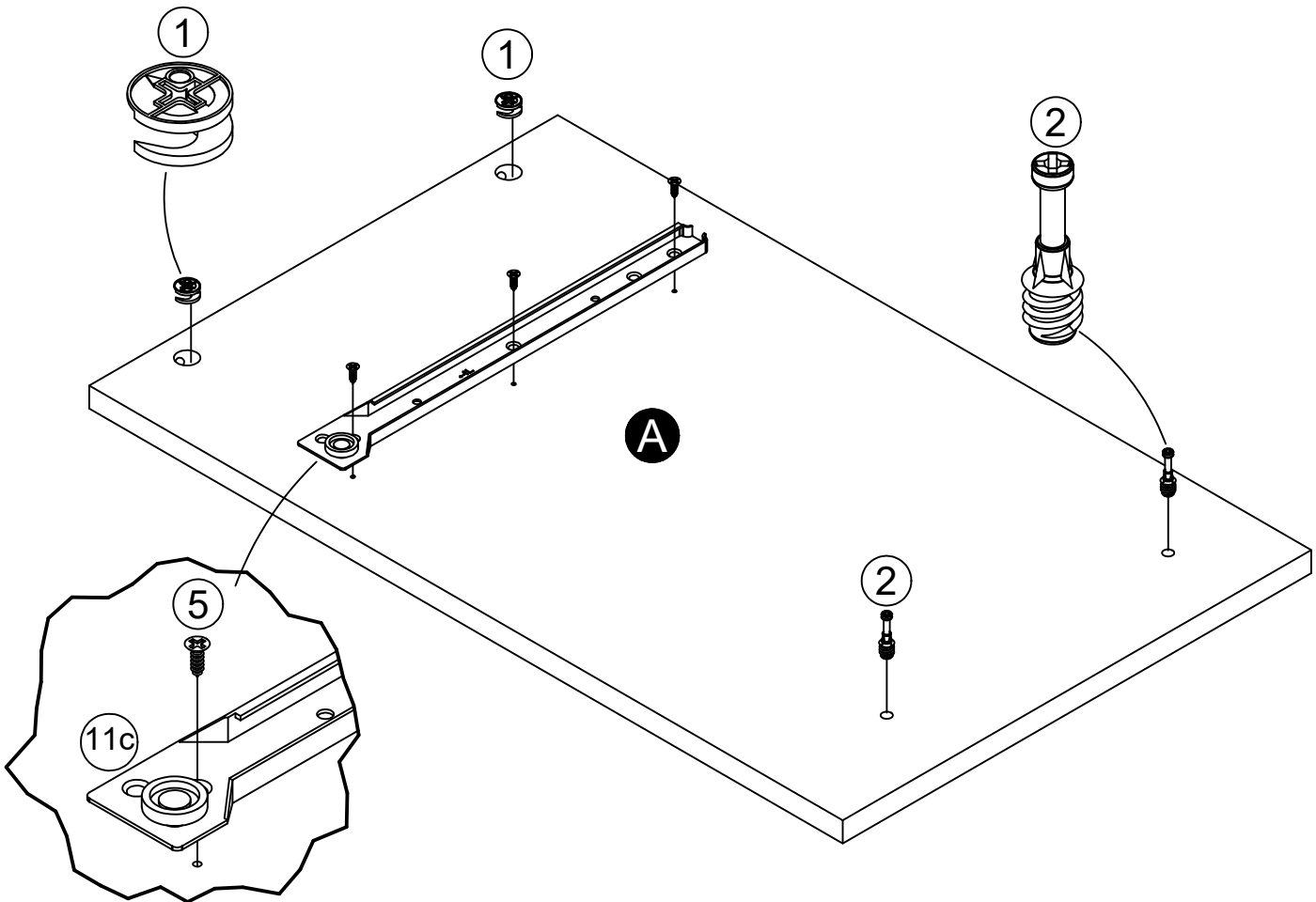

STEP 2

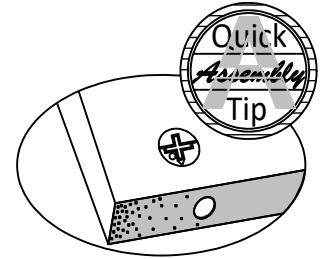
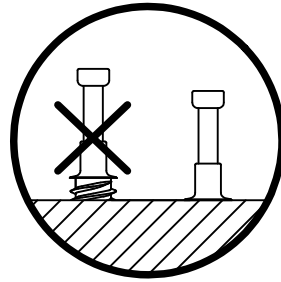
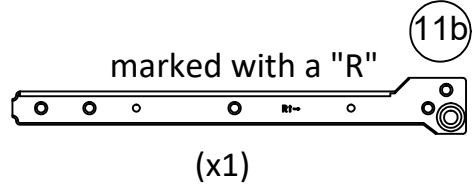
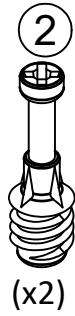
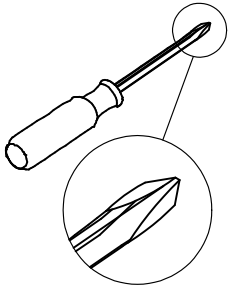

Proper orientation of CAM LOCK

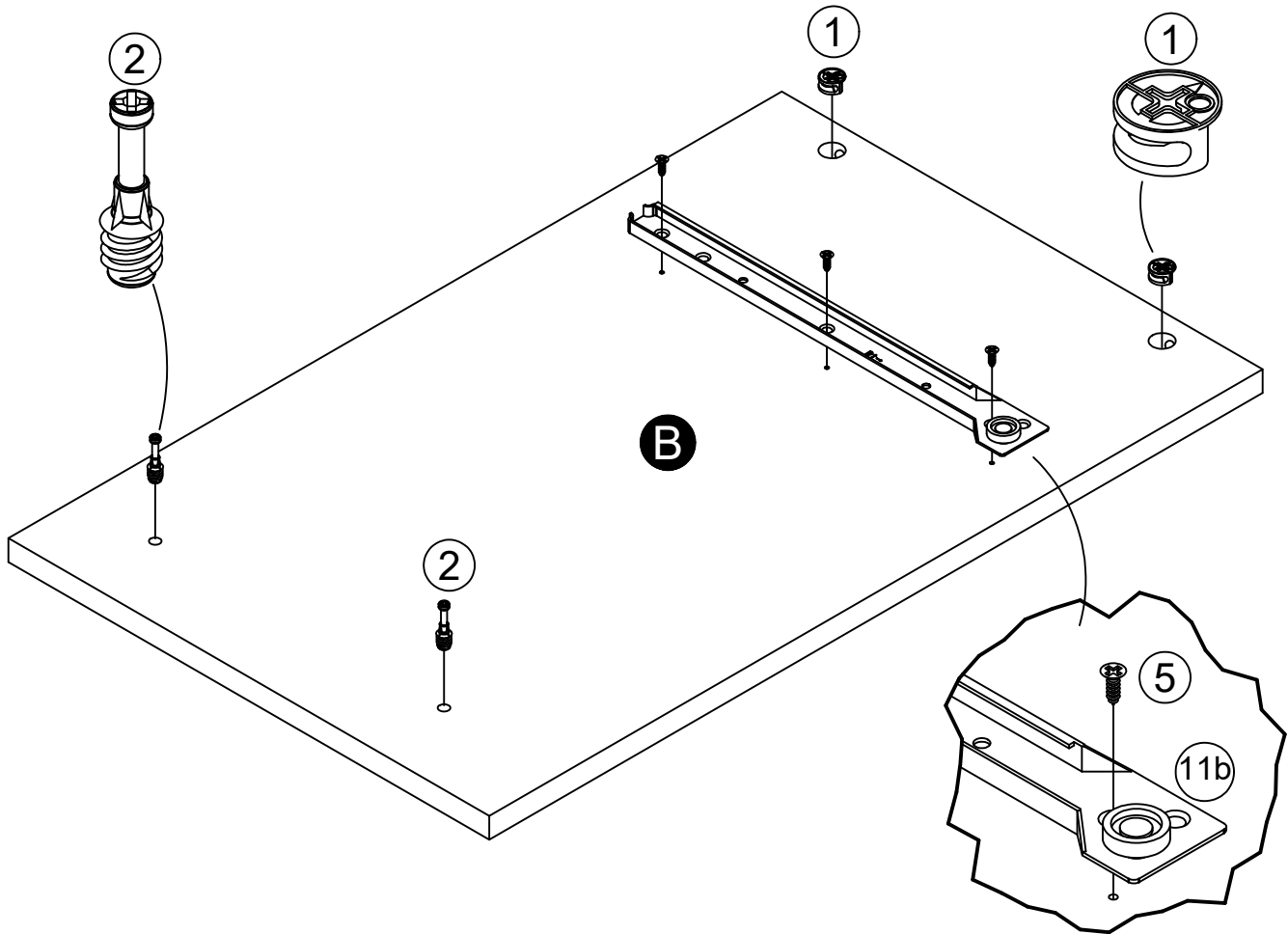

STEP 3

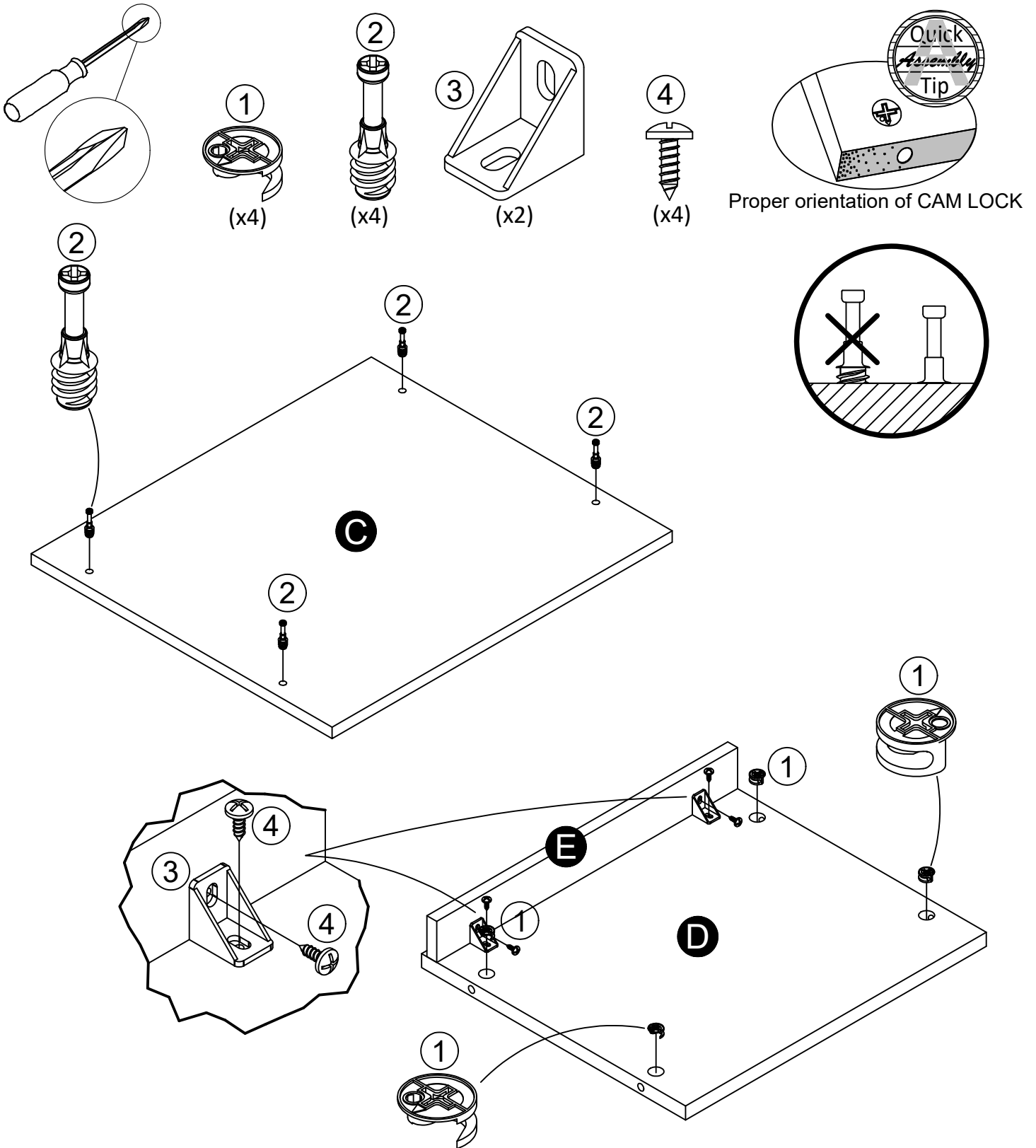

STEP 4

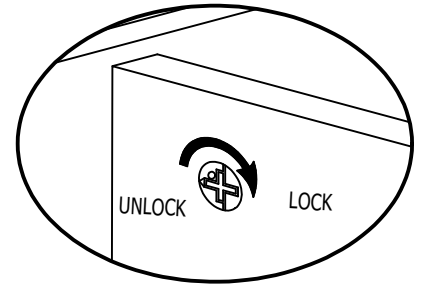
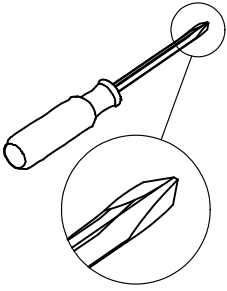

finished edges face up

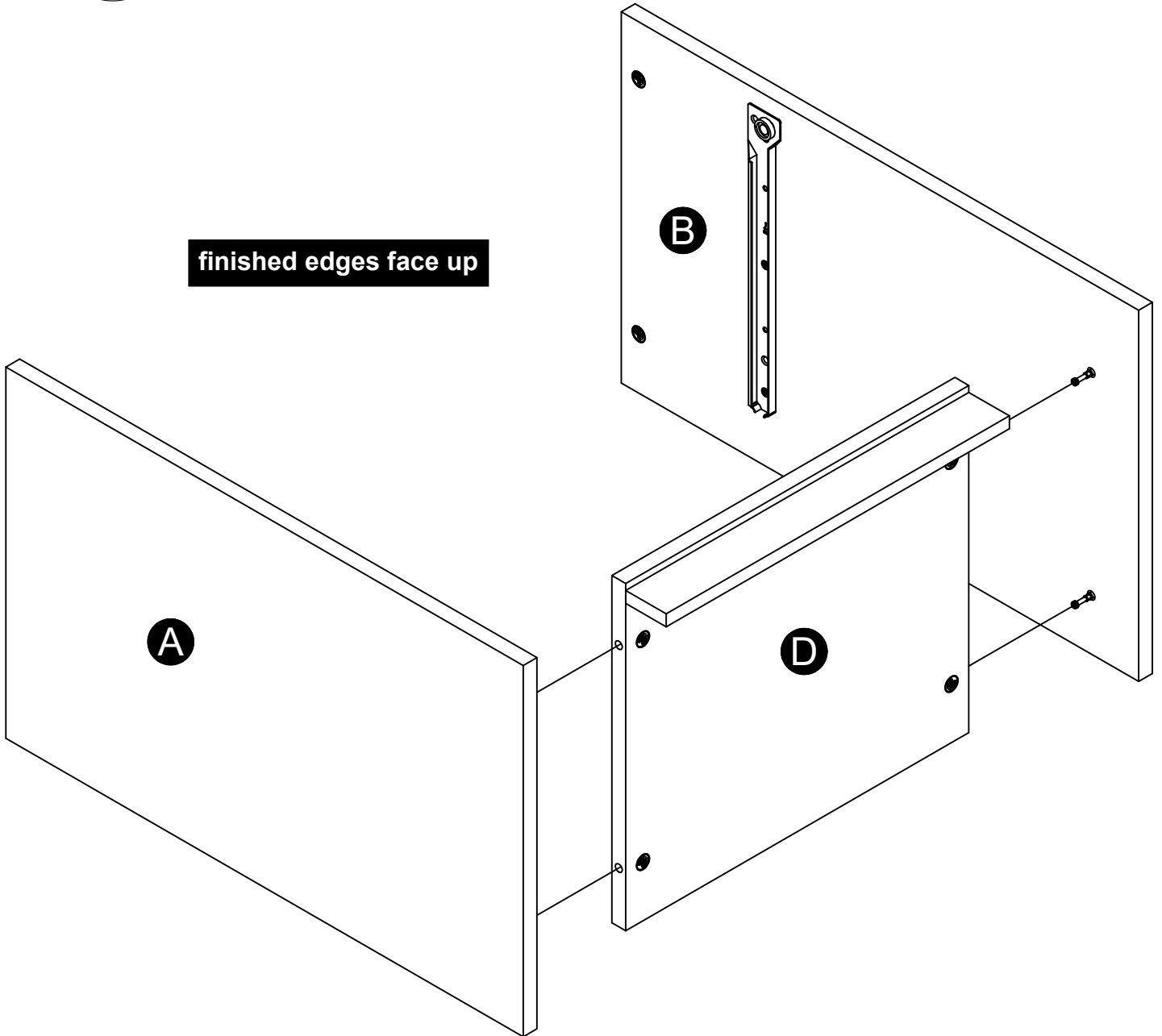

STEP 5

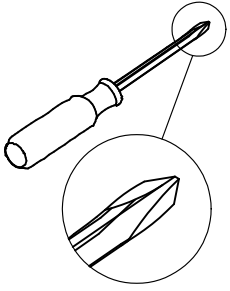

finished edges face up

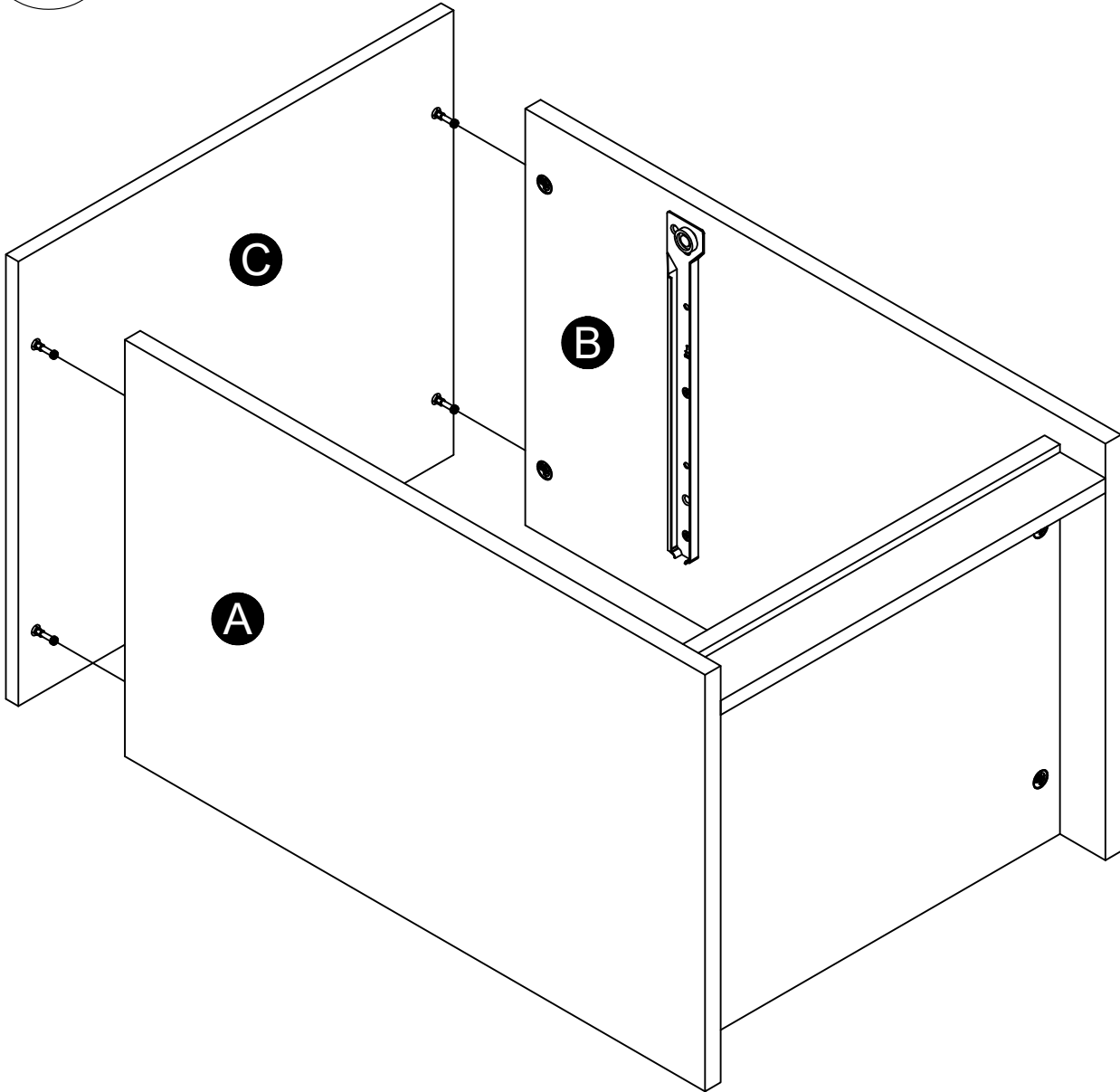
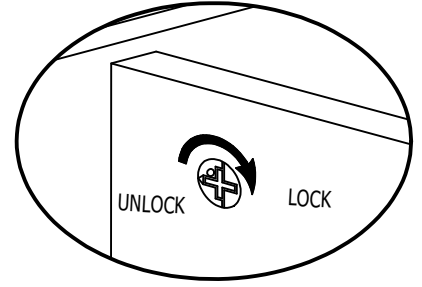

STEP 6

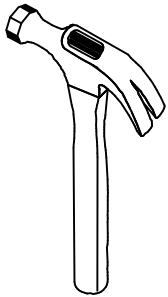

8



(x20)

IMPORTANT! THE BACK PANEL IS A STRUCTURAL PART OF THIS UNIT AND MUST BE INSTALLED PROPERLY.

Attached the back panel as shown nailing straight into the raw edges.
Assure that the unit is square.
Distance from corner to corner must be equal as shown.

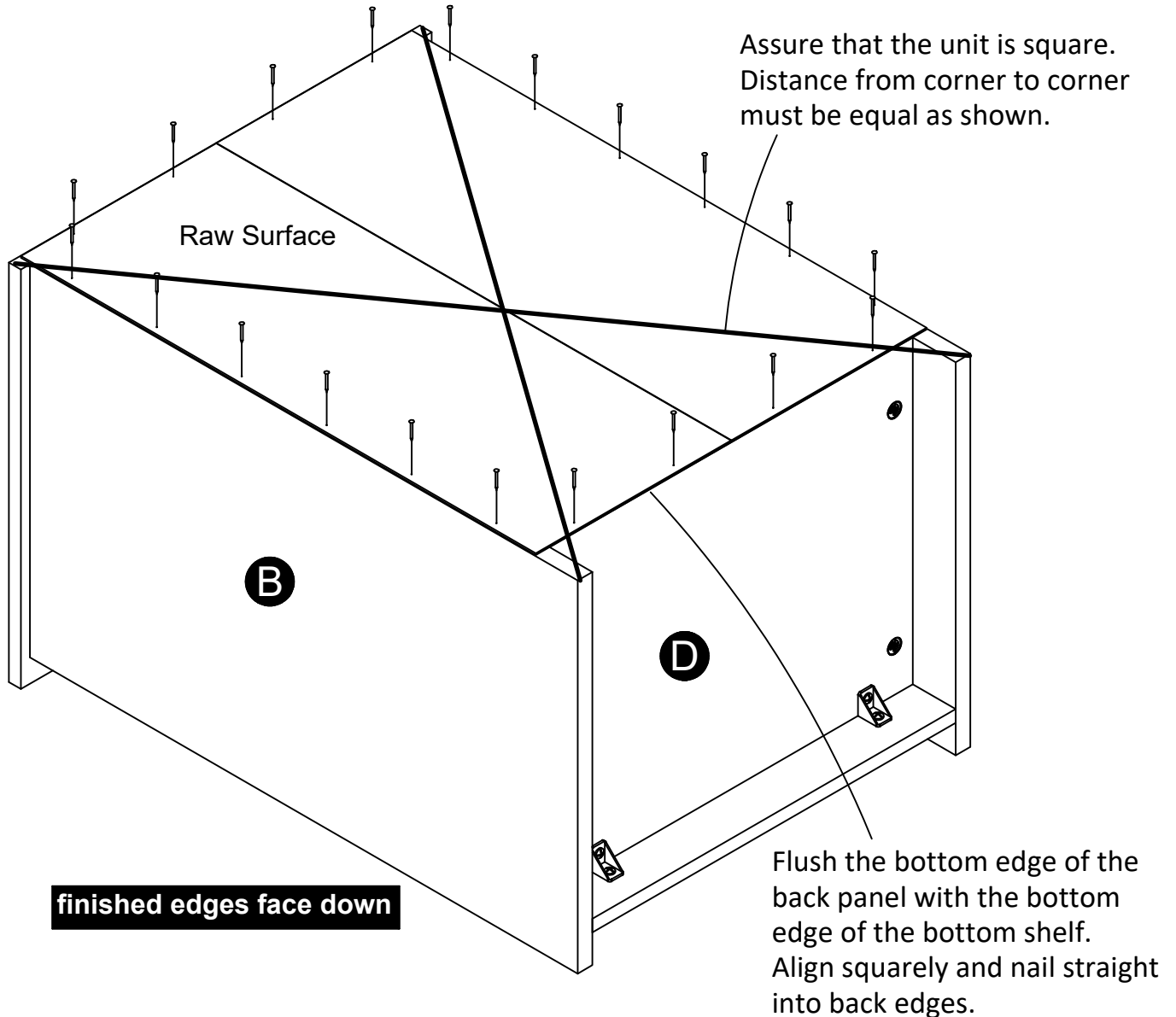

STEP 7

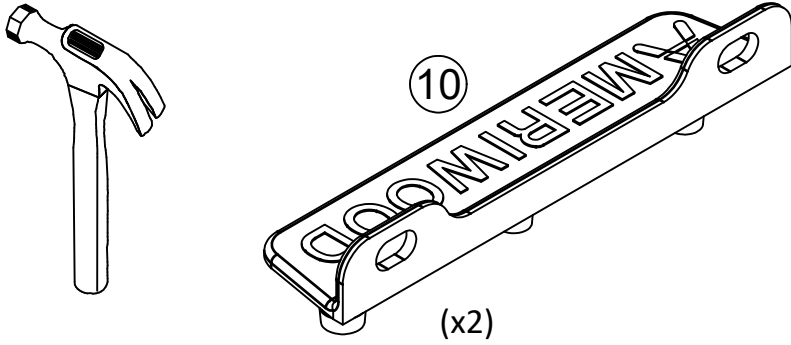

Carefully tap the drawer bracket (10) onto each drawer side as shown.

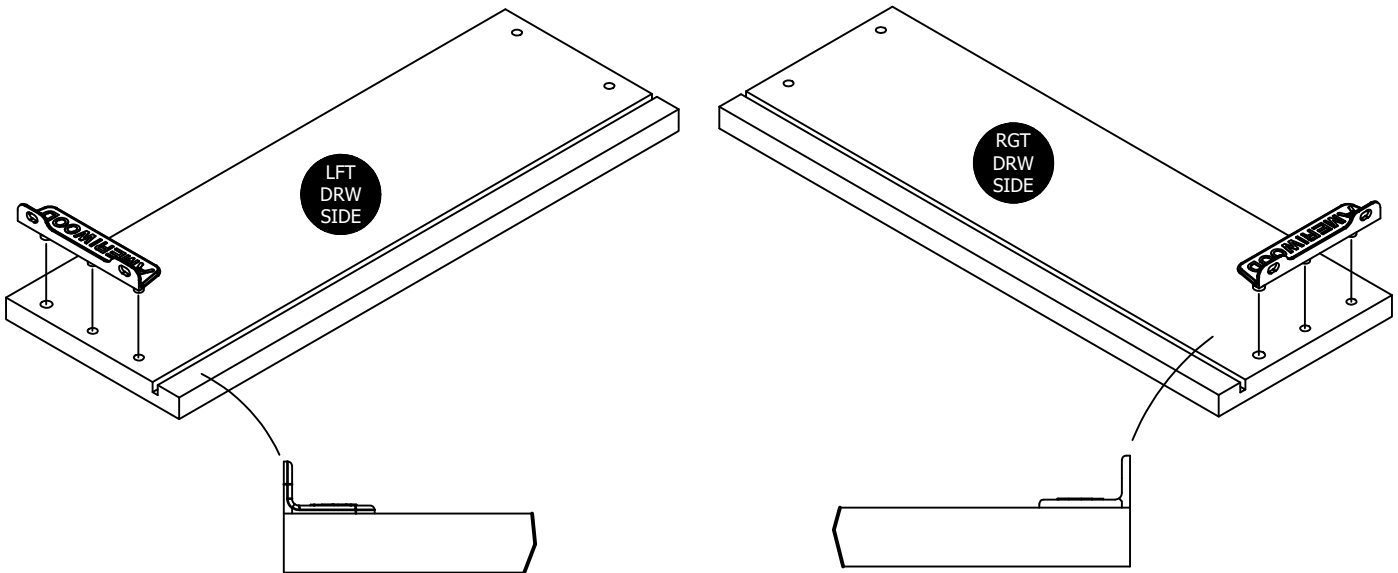

STEP 8

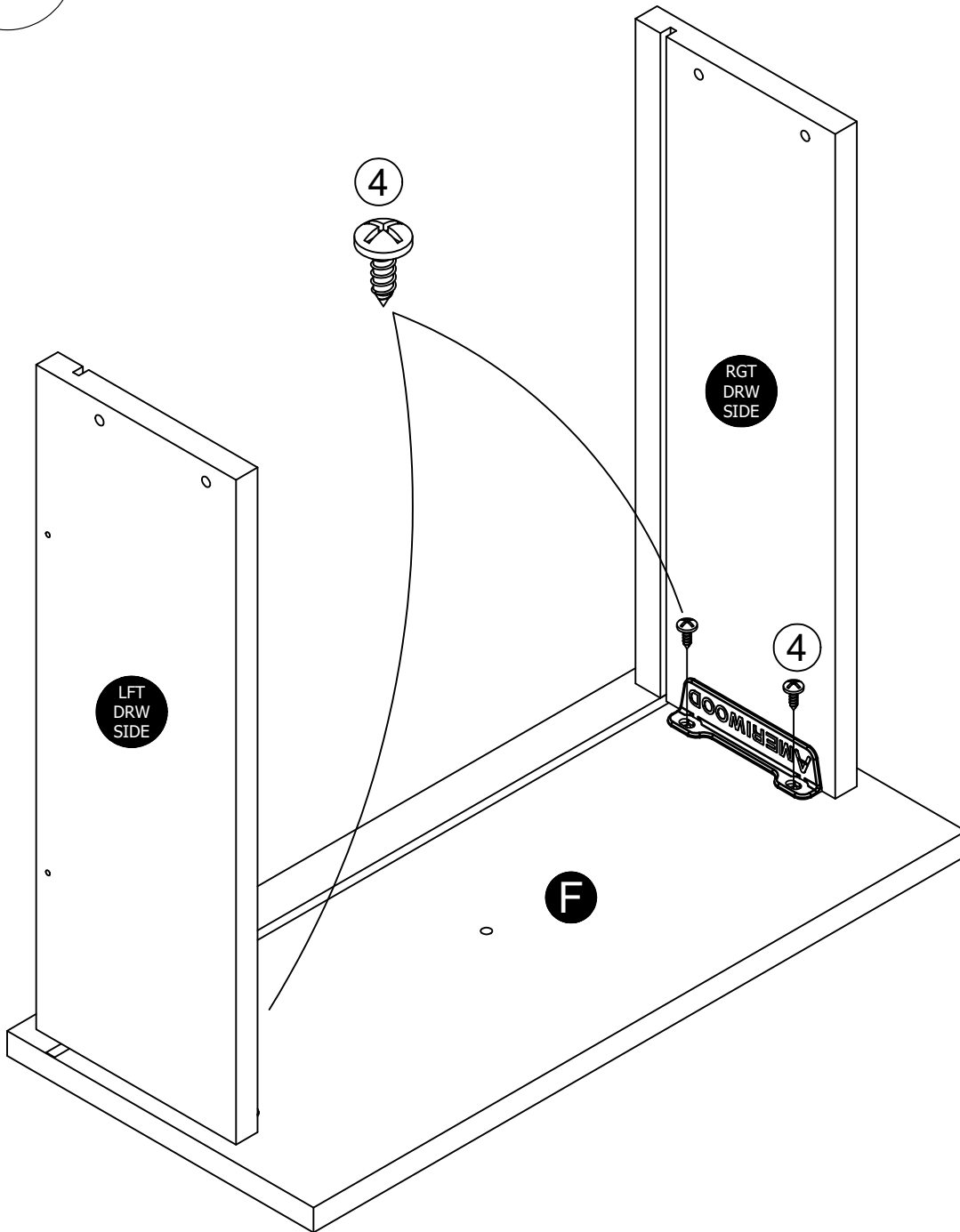
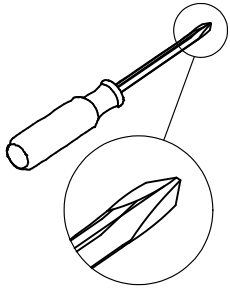

STEP 9

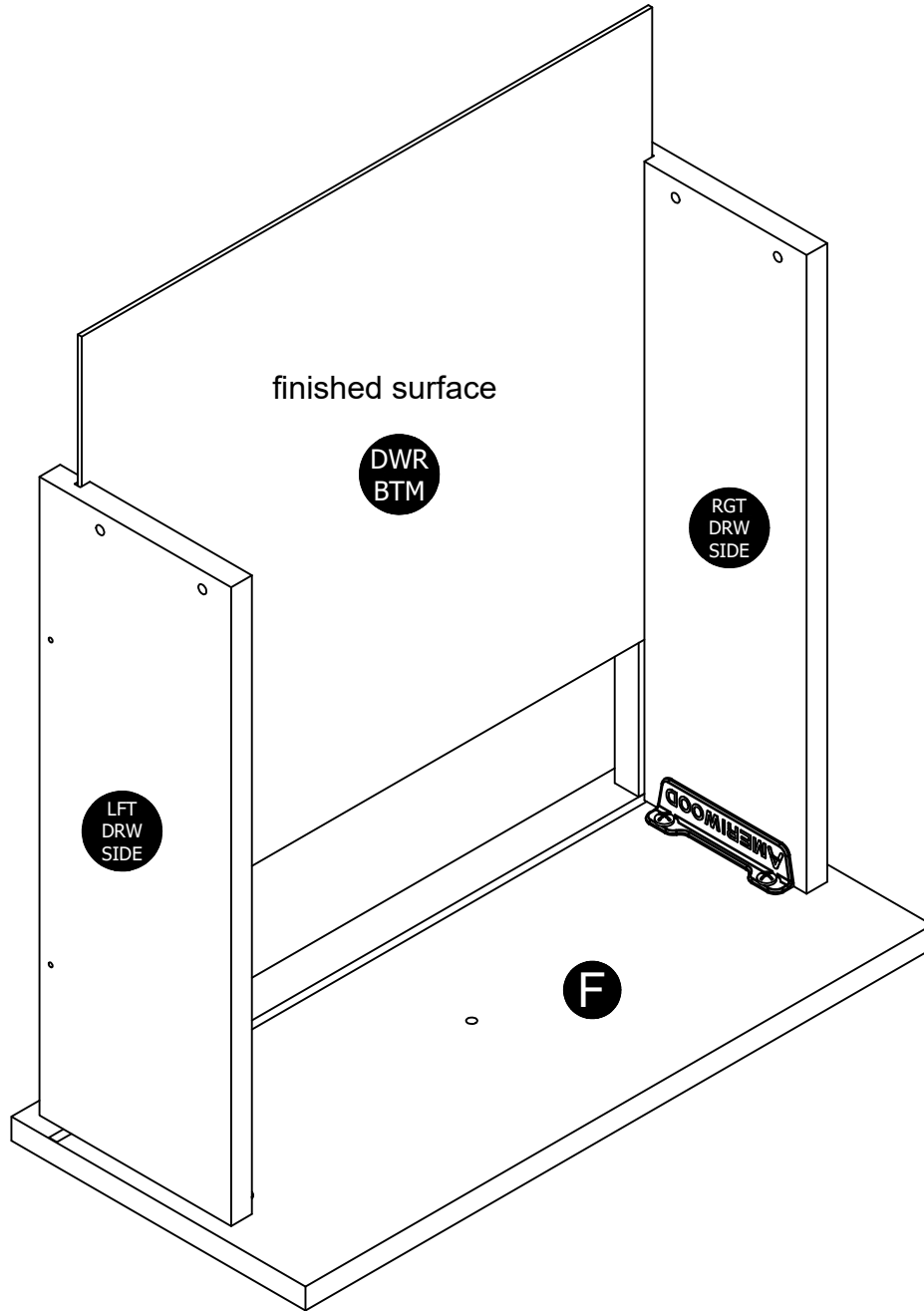

STEP 10

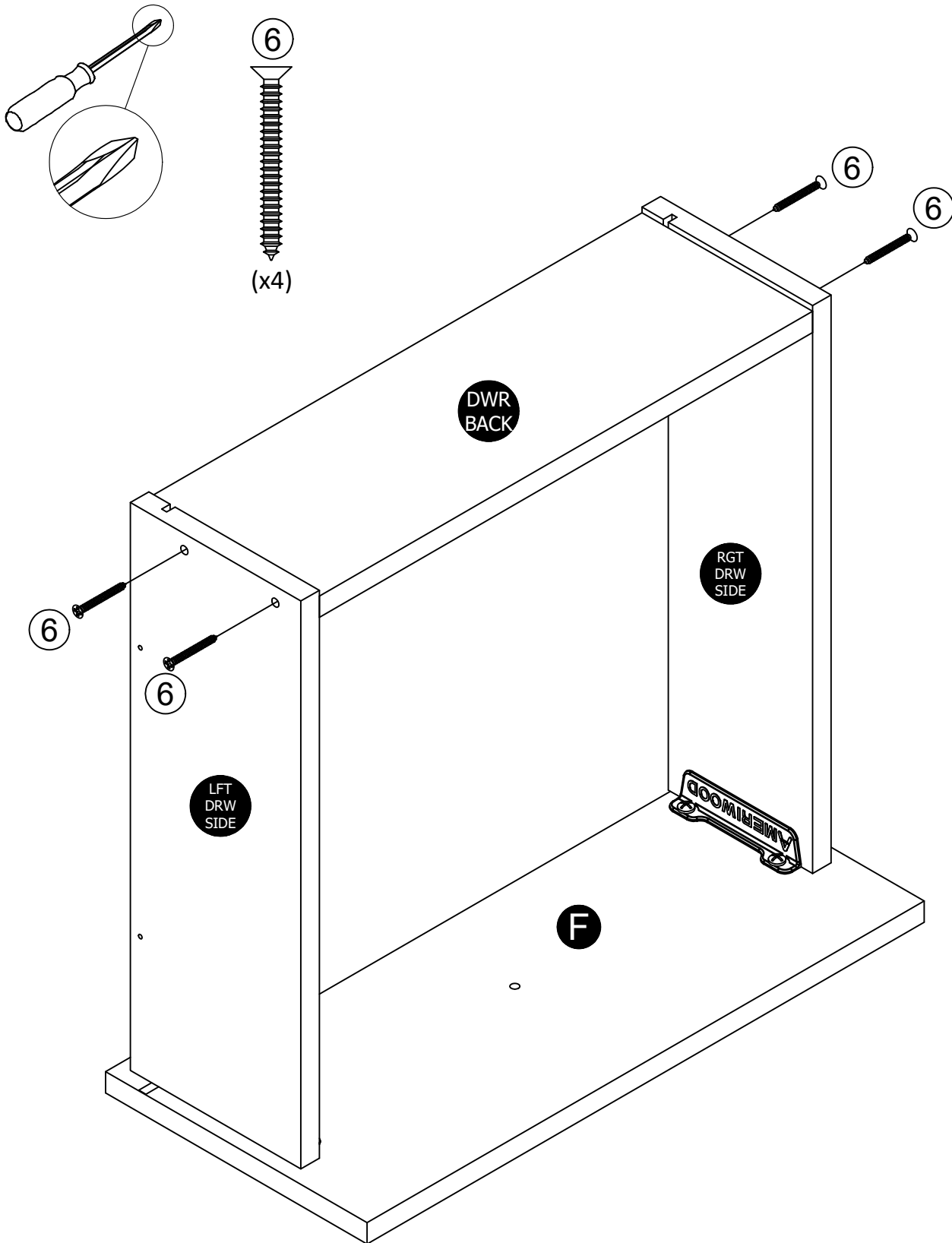

STEP 11

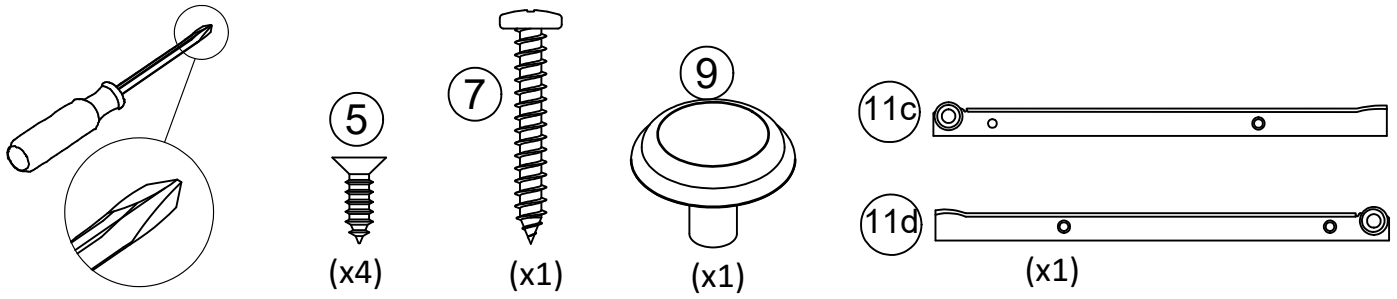

Attached drawer members (11c & 11d) first, then attach knob (9).

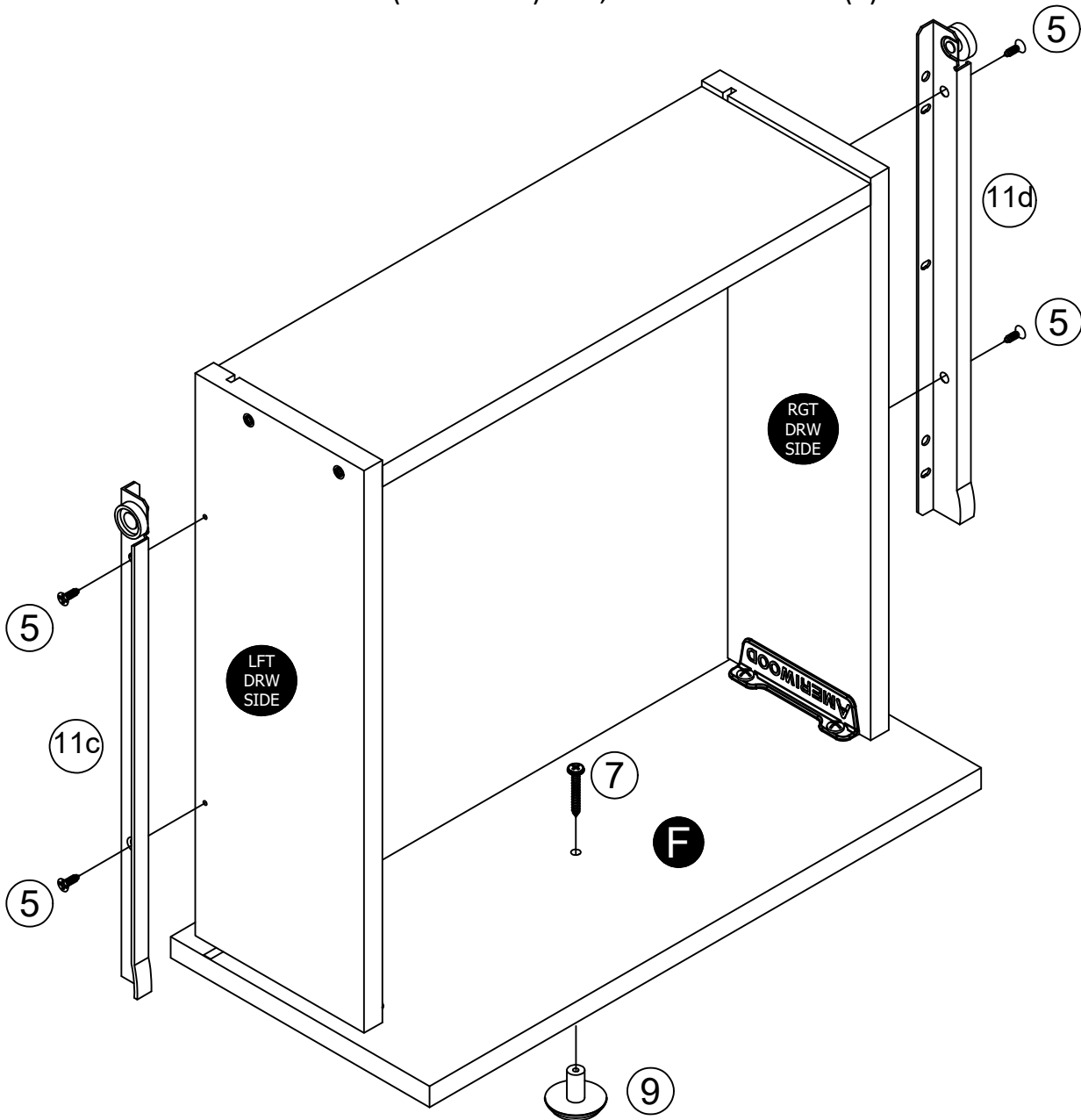

STEP 12

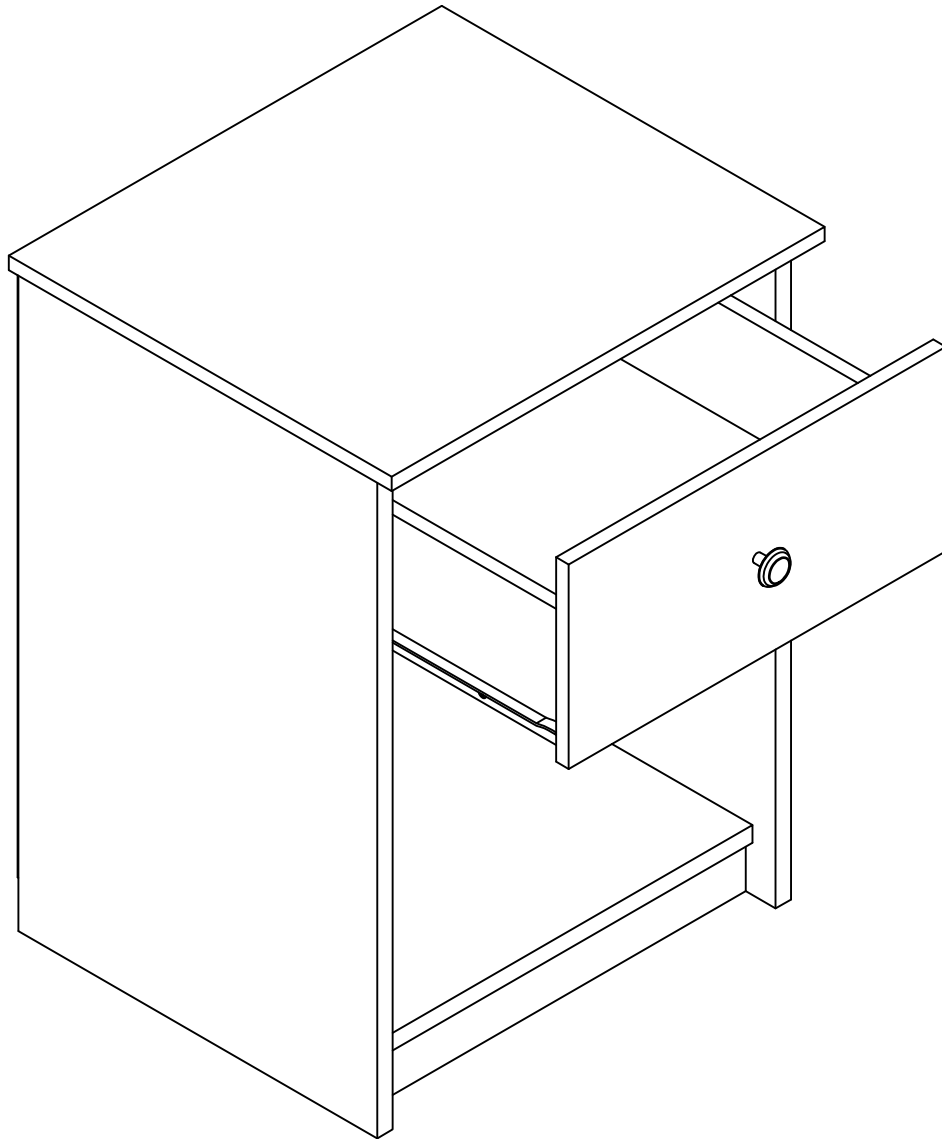

Note: The drawer bracket holes are slotted. Drawer front can be adjusted by loosening screws, making needed adjustments and re-tightening screws.

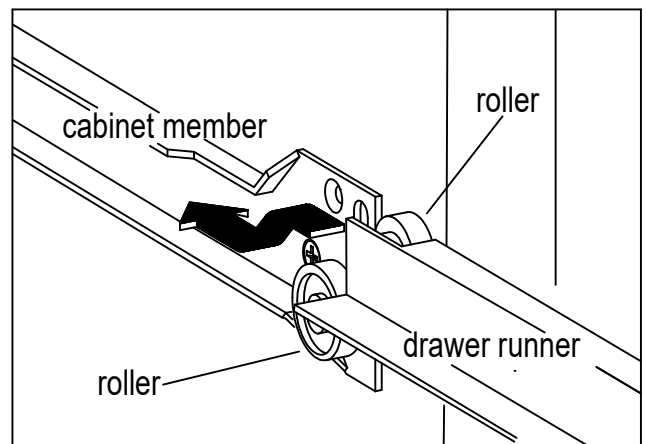

Maximum Loads

This unit has been designed to support the maximum loads shown. Exceeding these load limits could cause sagging, instability, product collapse, and/or serious injury.

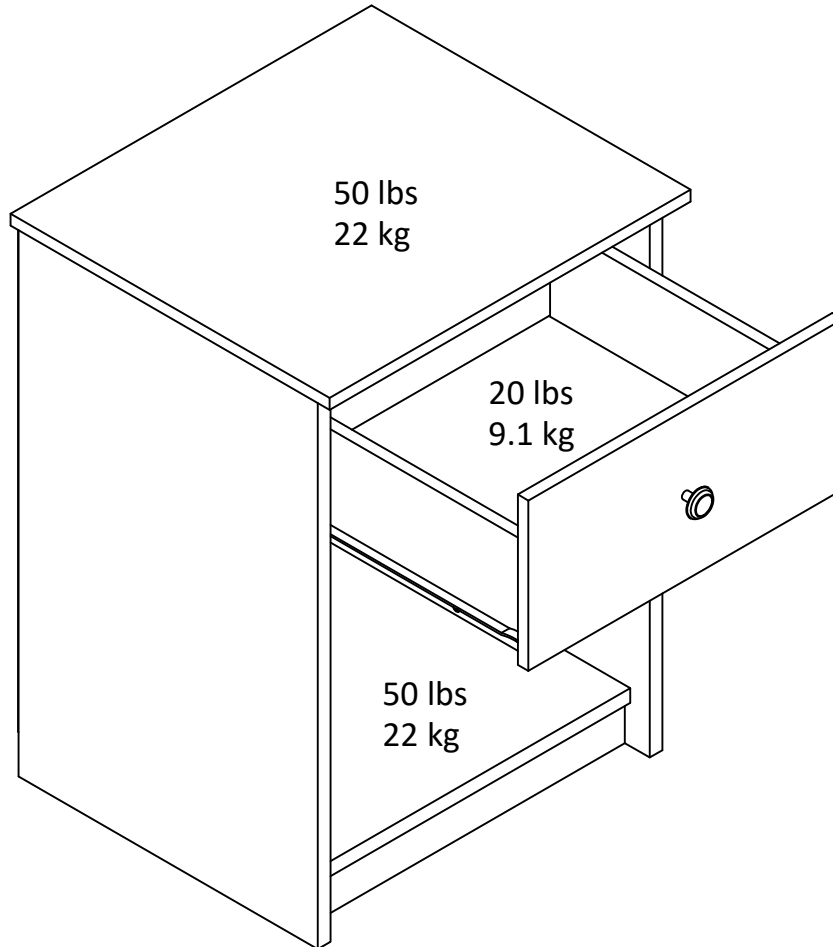

Warning: Risk of injury to persons - do not place a television on this furniture. This furniture is not approved for use with a television.

Certificate of Conformity

1. This certificate applies to the Dorel Home Furnishings, Inc. product identified by this instruction manual.
2. This certificate applies to compliance of this product with the CPSC Ban on Lead-Containing Paint (16 CFR 1303).
3. This product is distributed by: Dorel Home Furnishings, Inc.
410 East First Street South
Wright City, MO 63390
636-745-3351
4. Site of Manufacture: Cornwall, ON
5. See front page of instruction manual for date of manufacture.

Register your product to receive the following:



- * New trend details - sneak peek on what's new
- * Surveys - have a voice within our community
- * Exclusive deals and discount codes
- * Quick and easy replacement part service

To register your product, visit ameriwoodhome.com

5 Star Rating



Visit your local retailer's website, rate your purchased product and leave us some feedback!

We would like to extend a big "Thank You" to all of our customers for taking the time to assemble this Ameriwood Home product, and to give us your valuable feedback.

*Thank
You!*

Cubierta Delantera

Este libro de instrucciones contiene información **IMPORTANTE** de seguridad. Por favor lea y manténgalo para referencia en el futuro.

No Regrese este producto! Comuníquese con nuestro amigoso equipo de servicio al cliente para obtener ayuda.

Llámenos al: 1-800-489-3351 (Gratis) Lunes - Viernes 9am - 5pm CST

Visitar: www.ameriwoodhome.com

PRECAUCION

Este mueble puede volcarse y causar graves heridas y/o muerte.

Anclar el mueble a un poste de madera en la pared (si esto se requiere).

No Permita que los niños monten el mueble.

Mantenga los artículos más pesados en los cajones de abajo.

Consejos Útiles (página 2)

- Abra su artículo en el área donde usted planea utilizarlo para evitar levantar y moverlo menos
- Identificar, ordenar y contar las piezas antes de intentar ensamblar
- Las clavijas de compresión se golpean con un martillo
- Las diapositivas están marcadas con una R (derecha) y L (izquierda) para la colocación correcta
- Asegúrese de que siempre este el punto localizado en la parte superior de bloqueador de leva este volteado hacia borde exterior
- Utilizar todos los clavos para el panel de atrás y distribuirlos por igual
- El panel de atrás debe utilizarse para asegurarse de que la unidad quede fija y firme
- No use químicas fuertes ni limpiadores abrasivos en este artículo
- Nunca empuje, tire ni arrastre los muebles

Antes de Que Empieces (página 3)

- Lea cuidadosamente cada paso y siga el orden correcto
- Separar y contar todas sus piezas y hardware
- Dése suficiente espacio para el proceso de ensamble
- Tenga las siguientes herramientas: destornillador de cabeza plana, #2 cabeza Phillips
Destornillador y martillo
- Precaución: Si usa un taladro electrónico o un destornillador eléctrico para atornillar, por favor asegúrese que deje de atornillar cuando el tornillo este apretado. Fallar hacer esto puede causar barrer el tornillo.

Sistema de fijar el bloqueo de leva (página 3)

Esta sistema de fijar el bloqueo de leva sera usado en todo el proceso ensamble.

Página 18

¡IMPORTANTE! EL PANEL POSTERIOR ES UNA PARTE ESTRUCTURAL DE ESTA UNIDAD Y DEBE INSTALARSE CORRECTAMENTE.

Fije el panel trasero como se muestra, clavando directamente en los bordes sin rematar.

Asegúrese de que la unidad esté en ángulo recto.

La distancia de esquina a esquina debe ser igual a la que se muestra.

Asegúrese de que la unidad esté en ángulo recto.

La distancia de esquina a esquina debe ser igual a la que se muestra.

Nivele el borde inferior del panel posterior con el borde inferior del estante inferior.

Alinee en ángulo recto y clave directamente en los bordes posteriores.

Página 19

Golpee con cuidado el soporte del cajón (10) en cada lado tal como se muestra.

Página 23

Primero fije las correderas del cajón (11c y 11d). Luego fije la perilla (9).

Página 24

Nota: Los orificios del soporte del cajón están encajados. La parte frontal del cajón se puede ajustar si afloja los tornillos, hace los ajustes necesarios y vuelve a apretar los tornillos.

Página 25

CARGA MAXIMA

Esta unidad ha sido diseñada para soportar la carga máxima anotada. El exceder estos límites puede causar inestabilidad, colapsarse y/o causar serias lesiones.

ADVERTENCIA: Riesgo de lesiones a las personas - no coloque un televisor sobre muebles. Este mueble no está aprobado para su uso con un televisor.

Página 26

Registre su producto para recibir lo siguiente:

- * Detalles de nuevas tendencias - Vistazo a lo nuevo
- * Encuestas - alec su voz entre su comunidad
- * Códigos de ofertas y descuentos exclusivos
- * Fácil y rápido servicio de partes de remplace

Para registrar su producto, visite ameriwoodhome.com

Clasificación de 5 estrellas

Visite el sitio web de su tienda local, califique su comprado y denos sus comentarios!

Nos gustaría enviar un gran "Agradecimiento" a todos nuestros clientes por tomarse el tiempo de ensamblar este producto de Ameriwood Home, y por darnos sus valiosos comentarios.

Gracias

Couverture Avant

CE LIVRET D'INSTRUCTION CONTIENT DES INFORMATIONS **IMPORTANTES** SUR LA SÉCURITÉ. VEUILLEZ LIRE ET GARDER POUR UNE RÉFÉRENCE FUTURE

Ne retournez pas ce produit! Contactez notre équipe de service à la clientèle amicale d'abord pour obtenir de l'aide.

Appelez-nous: 1-800-489-3351 (sans frais) du Lundi au Vendredi de 9h à 17h Heure Centrale

Visitez: www.ameriwoodhome.com

ATTENTION

Le meuble peut basculer et causer des blessures graves ou la mort.

Ancrer le meuble à une planche murale dans le mur (si indiqué).

Ne laissez pas les enfants grimper sur le meuble.

Placez les articles lourds sur les étagères ou dans les tiroirs inférieurs.

Astuces Utiles (page 2)

-Ouvrez votre article dans la zone que vous prévoyez de le garder pour moins de levage lourd

-Identifier, trier et compter les pièces avant d'essayer d'assembler

-Les goujons de compression sont taraudés avec un Marteau

-Les glissières sont marquées d'un R (droit) et d'un L (gauche) pour un bon placement

-Assurez-vous toujours de faire face la pointe situé sur le haut de la Serrure de Came vers le bord extérieur

-Utiliser tous les clous fournis pour le panneau arrière et les répartir également

-Le panneau arrière doit être utilisé pour vous assurer que votre appareil est robuste

-N'utilisez pas de produits chimiques agressifs ou de nettoyeurs abrasifs sur cet appareil

-Ne jamais pousser, tirer, ou faire glisser votre meuble

Avant de Commencer (page 3)

-Lisez attentivement chaque étape et suivez le bon ordre

-Séparez et comptez toutes vos pièces et matériaux

-Donnez-vous suffisamment de place pour l'assemblage

-Avoir les outils suivants: tournevis à tête plate, #2 tournevis Phillips, et Marteau

-Attention: Si vous utilisez une perceuse électrique ou un tournevis électrique pour visser, veillez à ralentir et arrêter lorsque la vis est bien serrée. Le non-respect de cette consigne peut endommager la vis.

Système de Fixation de Came (page 3)

Ce Système de Fixation de Came sera utilisé tout au long de l'assemblage

Page 18

IMPORTANT ! LE PANNEAU ARRIÈRE CONSTITUE UNE PARTIE STRUCTURELLE DE CET ÉLÉMENT, ET DOIT ÊTRE INSTALLÉ CORRECTEMENT.

Fixez le panneau arrière comme indiqué en clouant directement dans les côtés bruts.

Assurez-vous que l'élément soit perpendiculaire.

La distance d'un coin à l'autre doit être égale, telle qu'indiquée.

Alignez le bord inférieur du panneau arrière avec le bord inférieur de l'étagère inférieure.

Alignez de manière perpendiculaire et clouez directement dans les bords arrière.

Page 19

Appuyez délicatement sur le support du tiroir (10) sur chaque côté du tiroir comme illustré.

Page 23

Fixez d'abord les éléments de tiroir (11c et 11d), puis fixez le bouton (9).

Page 24

Remarque : les trous du support du tiroir sont fendus. La façade du tiroir peut être ajustée en desserrant les vis, en effectuant les ajustements nécessaires et en resserrant les vis.

Page 25

CHARGES MAXIMALES

Ce meuble a été conçu pour supporter les charges maximales indiquées. En excédant ces limites de charge, le meuble pourrait devenir instable, s'effondrer, et/ou causer des blessures graves.

AVERTISSEMENT : Risque de blessure corporelle - ne pas placer une télévision sur ce meuble. Ce meuble n'est pas approuvé pour une utilisation avec une télévision.

Page 26

Enregistrez votre produit pour recevoir les éléments suivantes:

- * Détails sur les nouvelles tendances - un aperçu sur les nouveautés
- * Sondages - avoir une voix au sein de notre communauté
- * Offres exclusives et codes promo
- * Service de pièces de rechange rapide et facile

Pour enregistrer votre produit, visitez ameriwoodhome.com

5 Étoiles

Visitez le site Web de votre détaillant local, évaluez votre produit acheté et laissez-nous quelques commentaires !

Nous tenons à offrir un grand "Merci" à tous nos clients pour avoir pris le temps d'assembler ce produit "Ameriwood Home", et de nous donner vos commentaires précieux.

Merci